

LS125

Multiple probe UV Light Meter

User Manual V3.31

Please read this manual carefully before using and reserve it for reference.

I. Product Introduction

This instrument can support 9 kinds of UV probes according to different ultraviolet spectrum, measuring range, test hole diameter and application industry.

No.	Probe Model	Spectral response	Test Hole Diameter	Application Industry
1	UVC-X0	230nm-280nm	Φ10mm	Intensity and energy measurement of 254nm UV sterilization mercury lamp
2	UVCWP-X1	230nm-280nm	Φ10mm	Intensity and energy measurement of 254nm UV sterilization mercury lamp, waterproof
3	UVC-X2	210nm-250nm	Φ10mm	Intensity and energy measurement of 222nm UV germicidal lamps
4	UVCLED-X0	230nm-315nm	Φ10mm	Intensity and energy of 260nm-285nm UV LED sterilization lamp
5	UVB-X0	280nm-315nm	Φ10mm	General UVB intensity and energy measurement
6	UVA-X0	315nm-400nm	Φ10mm	Intensity and energy measurement of light source of high pressure mercury lamp in UV curing industry
7	UVA-X1	315nm-400nm	Φ10mm	General low power UVA intensity and energy measurement
8	UVA-X2	315nm-365nm	Φ10mm	Intensity and energy measurements of 340nm aging lamps
9	UVALED-X0	340nm-420nm	Φ10mm	Intensity and energy measurement of area light source of UV LED in UV curing industry
10	UVALED-X1	340nm-420nm	Φ1mm	Intensity and energy measurement of point light source of UV LED in UV curing industry
11	UVALED-X3	340nm-420nm	Φ10mm	General UVA+UVV LED intensity and energy measurement, low power measuring range
12	BL-X0	410nm-490nm	Φ10mm	Intensity and energy measurements of 450nm blue light

Standards for the product

JJG 879-2015 Verification Regulation of Ultraviolet Radiometers

WST 367-2012 Regulation of disinfection technique in healthcare settings

QB/T 2826-2017 Ultraviolet curing offset ink

II. Probe Parameters

1. UVC-X0 probe

1. Spectral response: 230nm-280nm, $\lambda_p = 254\text{nm}$
2. Power measuring range: 0 - 200000 $\mu\text{W}/\text{cm}^2$
3. Resolution: 0.1 $\mu\text{W}/\text{cm}^2$
4. Energy measuring range: 0-9999999 $\mu\text{J}/\text{cm}^2$
5. Record time: 0-99999s
6. Measuring accuracy(H is the standard value): $H < 50 \mu\text{W}/\text{cm}^2$: $\pm 5 \mu\text{W}/\text{cm}^2$, $H \geq 50 \mu\text{W}/\text{cm}^2$: $\pm 10\%H$
7. Sampling speed: 6 times/second
8. Optional unit: $\mu\text{W}/\text{cm}^2$ (default), mW/cm^2 , W/m^2
9. Test Hole Diameter: $\Phi=10\text{mm}$
10. Probe size: diameter 39mm * thickness 15mm

2. UVCWP-X1 probe

1. Spectral response: 230nm-280nm, $\lambda_p = 254\text{nm}$
2. Power measuring range: 0 - 200000 $\mu\text{W}/\text{cm}^2$
3. Resolution: 0.1 $\mu\text{W}/\text{cm}^2$
4. Energy measuring range: 0-9999999 $\mu\text{J}/\text{cm}^2$
5. Record time: 0-99999s
6. Measuring accuracy(H is the standard value): $H < 50 \mu\text{W}/\text{cm}^2$: $\pm 5 \mu\text{W}/\text{cm}^2$, $H \geq 50 \mu\text{W}/\text{cm}^2$: $\pm 10\%H$
7. Sampling speed: 6 times/second
8. Optional unit: $\mu\text{W}/\text{cm}^2$ (default), mW/cm^2 , W/m^2
9. Test Hole Diameter: $\Phi=10\text{mm}$
10. Probe size: diameter 50mm * thickness 20mm
11. Waterproof depth: 1m

3. UVC-X2 probe

1. Spectral response: 210nm-250nm, $\lambda_p = 222\text{nm}$
2. Power measuring range: 0 - 200000 $\mu\text{W}/\text{cm}^2$
3. Resolution: 0.1 $\mu\text{W}/\text{cm}^2$
4. Energy measuring range: 0-9999999 $\mu\text{J}/\text{cm}^2$
5. Record time: 0-99999s
6. Measuring accuracy(H is the standard value): $H < 50 \mu\text{W}/\text{cm}^2$: $\pm 5 \mu\text{W}/\text{cm}^2$, $H \geq 50 \mu\text{W}/\text{cm}^2$: $\pm 10\%H$
7. Sampling speed: 6 times/second
8. Optional unit: $\mu\text{W}/\text{cm}^2$ (default), mW/cm^2 , W/m^2
9. Test Hole Diameter: $\Phi=10\text{mm}$
10. Probe size: diameter 39mm * thickness 15mm

4. UVLED-X0 probe

1. Spectral response: 230nm-315nm, suitable for testing 260nm-285nm sterilization UV LED (wide spectral response range, avoid using in strong ambient light)
2. Power measuring range: 0 - 200000 $\mu\text{W}/\text{cm}^2$
3. Resolution: 0.1 $\mu\text{W}/\text{cm}^2$
4. Energy measuring range: 0-9999999 $\mu\text{J}/\text{cm}^2$
5. Record time: 0-99999s
6. Measuring accuracy(H is the standard value): $H < 50 \mu\text{W}/\text{cm}^2$: $\pm 5 \mu\text{W}/\text{cm}^2$, $H \geq 50 \mu\text{W}/\text{cm}^2$: $\pm 10\%H$ %
7. Sampling speed: 6 times/second
8. Optional unit: $\mu\text{W}/\text{cm}^2$ (default), mW/cm^2 , W/m^2
9. Test Hole Diameter: $\Phi=10\text{mm}$
10. Probe size: diameter 39mm * thickness 15mm

5. UVB-X0 probe

1. Spectral response: 280nm-315nm, $\lambda_p = 310\text{nm}$, suitable for measuring UVB light source that peak wavelength at 297nm, 308nm, 313nm etc.
2. Power measuring range: 0 - 200000 $\mu\text{W}/\text{cm}^2$

3. Resolution: $0.1\mu\text{W}/\text{cm}^2$
4. Energy measuring range: $0-9999999\mu\text{J}/\text{cm}^2$
5. Record time: $0-99999\text{s}$
6. Measuring accuracy(H is the standard value): $H<50\mu\text{W}/\text{cm}^2$: $\pm 5\mu\text{W}/\text{cm}^2$, $H\geq 50\mu\text{W}/\text{cm}^2$: $\pm 10\%H$
7. Sampling speed: 6 times/second
8. Optional unit: $\mu\text{W}/\text{cm}^2$ (default), mW/cm^2 , W/m^2
9. Test Hole Diameter: $\Phi=10\text{mm}$
10. Probe size: diameter 39mm * thickness 15mm

6. UVA-X0 probe

1. Spectral response: 315nm-400nm, $\lambda_p = 365\text{nm}$
2. Power measuring range: $0 - 2000\text{mW}/\text{cm}^2$
3. Resolution: $0.1\text{mW}/\text{cm}^2$
4. Energy measuring range: $0-9999999\text{mJ}/\text{cm}^2$
5. Record time: $0-99999\text{s}$
6. Measuring accuracy(H is the standard value): $H<5\text{mW}/\text{cm}^2$: $\pm 0.5\text{mW}/\text{cm}^2$, $H\geq 5\text{mW}/\text{cm}^2$: $\pm 10\%H$
7. Sampling speed: 2048 times/second
8. Optional unit: mW/cm^2 (default), W/m^2
9. Test Hole Diameter: $\Phi=10\text{mm}$
10. Probe size: length 39mm * width 32mm * thickness 15mm

7. UVA-X1 probe

1. Spectral response: 315nm-400nm, $\lambda_p = 365\text{nm}$
2. Power measuring range: $0 - 200000\mu\text{W}/\text{cm}^2$
3. Resolution: $0.1\mu\text{W}/\text{cm}^2$
4. Energy measuring range: $0-9999999\mu\text{J}/\text{cm}^2$
5. Record time: $0-99999\text{s}$
6. Measuring accuracy(H is the standard value): $H<50\mu\text{W}/\text{cm}^2$: $\pm 5\mu\text{W}/\text{cm}^2$, $H\geq 50\mu\text{W}/\text{cm}^2$: $\pm 10\%H$
7. Sampling speed: 6 times/second
8. Optional unit: $\mu\text{W}/\text{cm}^2$ (default), mW/cm^2 , W/m^2

9. Test Hole Diameter: $\Phi=10\text{mm}$
10. Probe size: length 39mm * width 32mm * thickness 15mm

8. UVA-X2 probe

1. Spectral response: 315nm-365nm, $\lambda_p = 340\text{nm}$
2. Power measuring range: 0 - 200000 $\mu\text{W}/\text{cm}^2$
3. Resolution: 0.1 $\mu\text{W}/\text{cm}^2$
4. Energy measuring range: 0-9999999 $\mu\text{J}/\text{cm}^2$
5. Record time: 0-99999s
6. Measuring accuracy(H is the standard value): $H < 50 \mu\text{W}/\text{cm}^2$: $\pm 5 \mu\text{W}/\text{cm}^2$, $H \geq 50 \mu\text{W}/\text{cm}^2$: $\pm 10\%H$
7. Sampling speed: 6 times/second
8. Optional unit: $\mu\text{W}/\text{cm}^2$ (default), mW/cm^2 , W/m^2
9. Test Hole Diameter: $\Phi=10\text{mm}$
10. Probe size: length 39mm * width 32mm * thickness 15mm

9. UVALED-X0 probe

1. Spectral response: 340nm-420nm, calibrated with 395nm UV LED
2. Power measuring range: 0 - 20000 mW/cm^2
3. Resolution: 1 mW/cm^2
4. Energy measuring range: 0-9999999 mJ/cm^2
5. Record time: 0-99999s
6. Measuring accuracy(H is the standard value): $H < 50\text{mW}/\text{cm}^2$: $\pm 5\text{mW}/\text{cm}^2$, $H \geq 50\text{mW}/\text{cm}^2$: $\pm 10\%H$
7. Sampling speed: 2048 times/second
8. Optional unit: mW/cm^2 (default), W/cm^2 , W/m^2
9. Test Hole Diameter: $\Phi=10\text{mm}$
10. Probe size: length 39mm * width 32mm * thickness 15mm

10. UVALED-X1 probe

1. Spectral response: 340nm-420nm, calibrated with 395nm UV LED
2. Power measuring range: 0 - 20000 mW/cm^2

3. Resolution: $1\text{mW}/\text{cm}^2$
4. Energy measuring range: $0\text{-}99999999\text{mJ}/\text{cm}^2$
5. Record time: $0\text{-}99999\text{s}$
6. Measuring accuracy(H is the standard value): $H < 50\text{mW}/\text{cm}^2$: $\pm 5\text{mW}/\text{cm}^2$, $H \geq 50\text{mW}/\text{cm}^2$: $\pm 10\%H$
7. Sampling speed: 2048 times/second
8. Optional unit: mW/cm^2 (default), W/cm^2 , W/m^2
9. Test Hole Diameter: $\Phi=1\text{mm}$
11. Probe size: length 39mm * width 32mm * thickness 15mm

11. UVALED-X3 probe

1. Spectral response: 340nm-420nm, calibrated with 395nm UV LED
2. Power measuring range: $0\text{ - }200000\mu\text{W}/\text{cm}^2$
3. Resolution: $0.1\mu\text{W}/\text{cm}^2$
4. Energy measuring range: $0\text{-}99999999\mu\text{J}/\text{cm}^2$
5. Record time: $0\text{-}99999\text{s}$
6. Measuring accuracy(H is the standard value): $H < 50\mu\text{W}/\text{cm}^2$: $\pm 5\mu\text{W}/\text{cm}^2$, $H \geq 50\mu\text{W}/\text{cm}^2$: $\pm 10\%H$
7. Sampling speed: 6 times/second
8. Optional unit: $\mu\text{W}/\text{cm}^2$ (default), mW/cm^2 , W/m^2
9. Test Hole Diameter: $\Phi=10\text{mm}$
10. Probe size: length 39mm * width 32mm * thickness 15mm

12. BL-X0 probe

1. Spectral response: 410nm-490nm, calibrated with 450nm UV LED
2. Power measuring range: $0\text{ - }2000\text{mW}/\text{cm}^2$
3. Resolution: $0.1\text{mW}/\text{cm}^2$
4. Energy measuring range: $0\text{-}99999999\text{mJ}/\text{cm}^2$
5. Record time: $0\text{-}99999\text{s}$
6. Measuring accuracy(H is the standard value): $H < 50\text{mW}/\text{cm}^2$: $\pm 5\text{mW}/\text{cm}^2$, $H \geq 50\text{mW}/\text{cm}^2$: $\pm 10\%H$
7. Sampling speed: 2048 times/second
8. Optional unit: mW/cm^2 (default), W/m^2

9. Test Hole Diameter: $\Phi=10\text{mm}$

10. Probe size: length 39mm * width 32mm * thickness 15mm

13. Host Parameters

1. Host weight: about 194g
2. Host size: 148mm * 76mm * 26mm (L*W*H)
3. Display: 240*160 dot matrix LCD
4. Power supply: 4 AAA alkaline battery
5. Probe connection: push pull (Snap-in style), Aviation socket.

III. The spectral response curves of probes

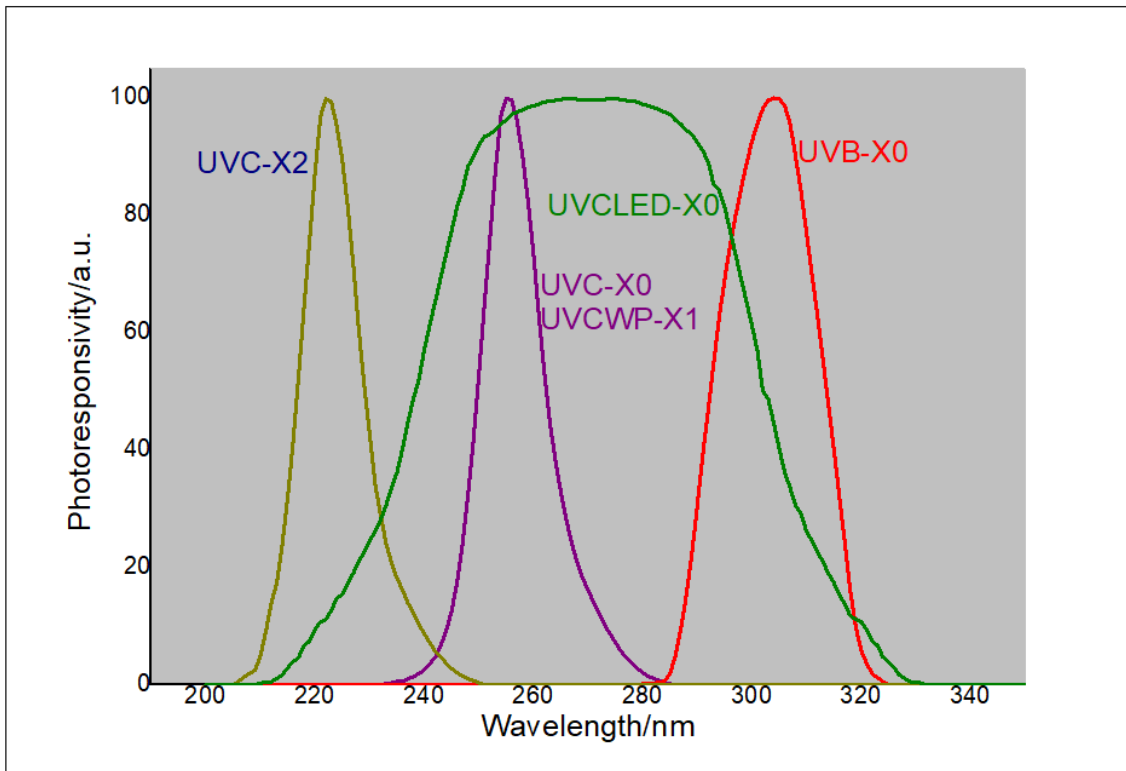

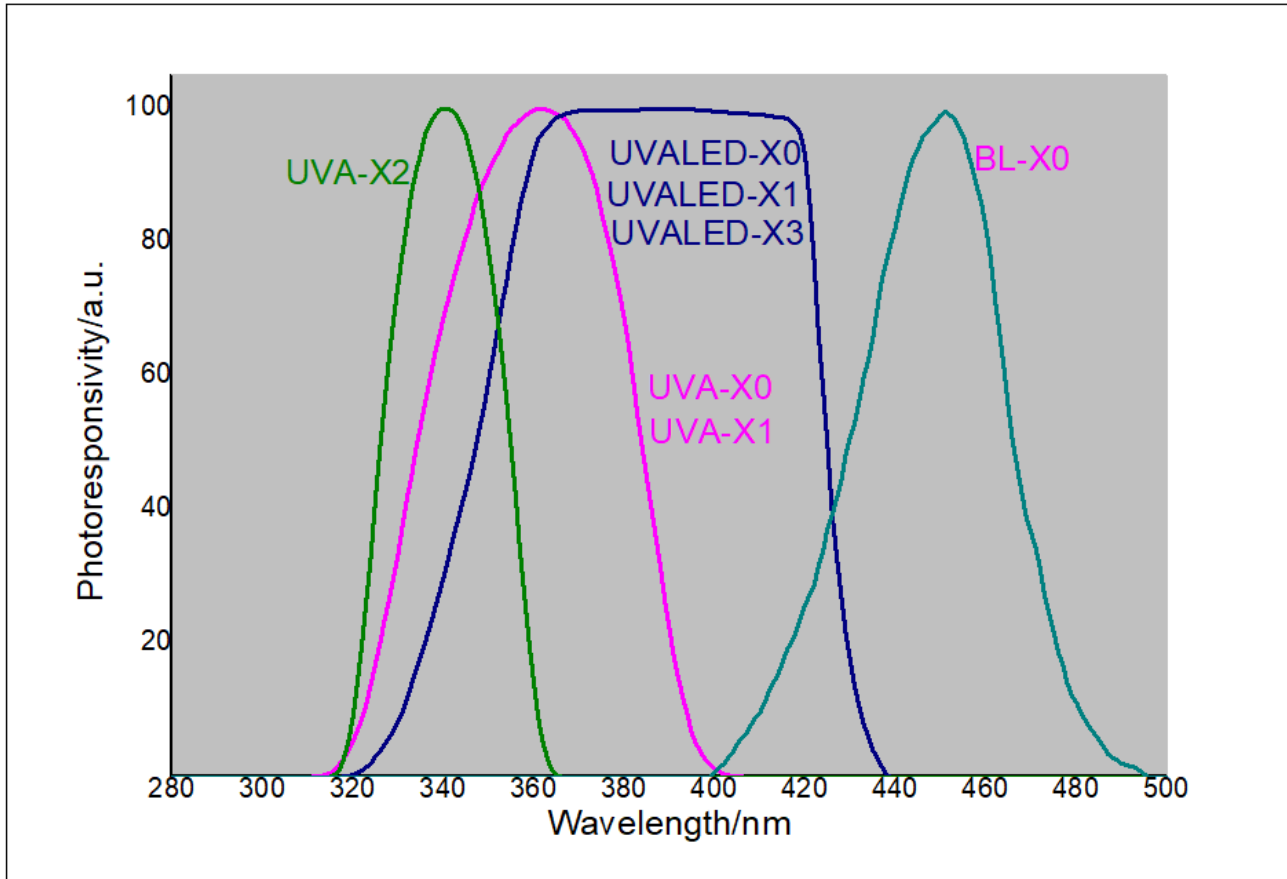

IV. Product features

1. Replaceable probe design, support 9 UV probes.
2. Advanced digital probe technology, it has high precision and good anti - jamming ability.
3. Instrument intelligent recognize probe type and adjust the display interface intelligently.
4. A variety of spectral range, measuring range, test hole size of the probe to adapt to different application industries.
5. For LED point light source, 1mm test hole can make it more convenient to measure.
6. Statistical functions, real-time value, maximum value, minimum value, average value, time, energy values are displayed at the same time.

V. Operations

1. Power on/off

- **Power on:** Press  to power on the instrument. After powering on, the instrument displays the instrument parameters and probe parameters, and enter the measuring interface, as shown below:

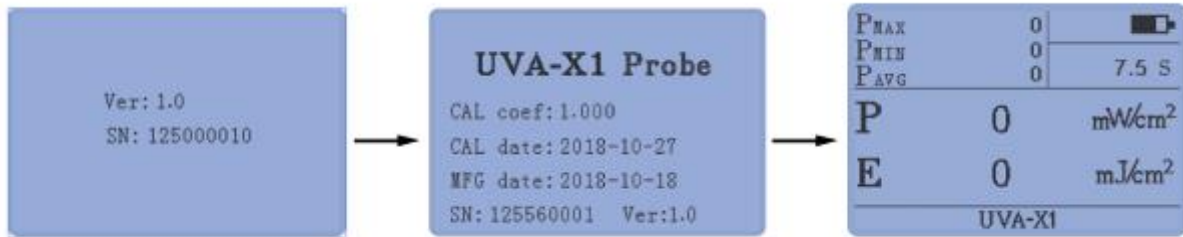

- **Power off:** Long press the button to power off; or the instrument will automatically power off in 10mins after no operation when Auto Off set ON.
- The data recorded before shutdown will be automatically saved to the history record during automatic shutdown. (No. 1, the latest record).

2. Parameter settings mode

In the off state, long press the button 3s to enter the parameter setting mode.

In the setting mode, and are Select buttons, and is the Confirm button.

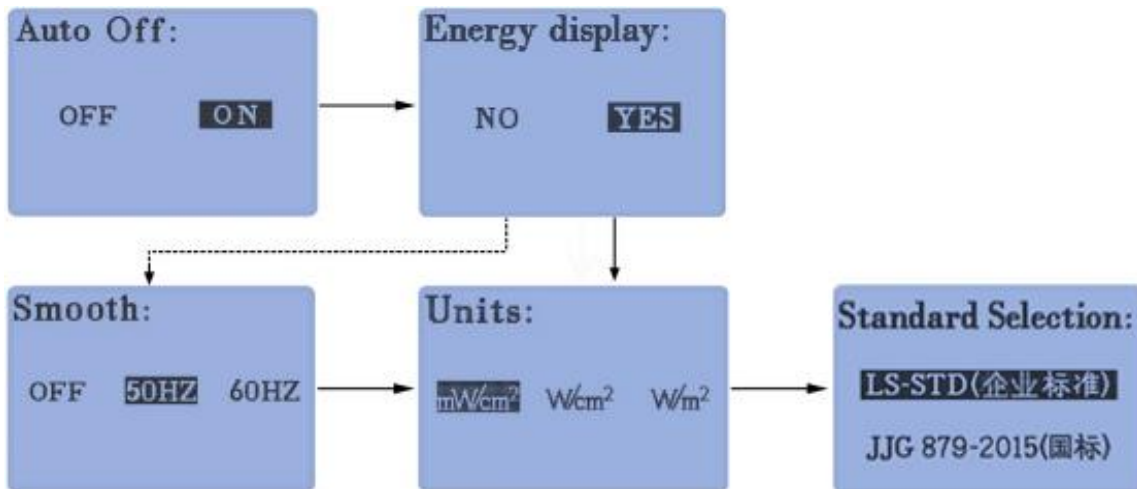

A. Select whether to automatically power off (Auto Off: ON/OFF)

Short press the or button to select ON/OFF

Selecting ON indicates that the instrument automatically powers off in 10mins after no operation.

Selecting OFF indicates that the user has to manually turn the instrument off, and the instrument will not automatically power off.



Short press button to complete the setting and enter the next Set option.

B. Whether to display the energy value (Energy display: NO/YES)

Short press the or button to select NO/YES

Short press " button to complete the setting and enter the next Set option.

C. Smooth (OFF/50HZ/60HZ, only probes with high sampling speed have this option)

If UV light source powered by alternating current (AC) power supply, the AC frequency affects the power measurement, so that the smoothing process becomes necessary for those probes with high sampling speed (2048 times/second), enter the smooth setting mode, short press the " or " button to select.



OFF: Select this option, if UV light is DC powered and does not need smoothing.

50HZ: Select this option for 50HZ AC.

60HZ: Select this option for 60HZ AC.

Short press " button to complete the setting and enter the next Set option.

D. Select the unit (Units: $\mu\text{W}/\text{cm}^2$, mW/cm^2 , W/cm^2 , W/m^2)

Short press the " or " button to select the unit required (Different probes have different options).

Short press " button to complete the setting. When the probe model is UVALED-X0, UVALED-X1 and UVALED-X3, the meter enter the next setting item. If not, the meter enter the measurement mode.

E. Standard Selection



Short press the " button or " button to select the standard.

LS-STD (企业标准): The meter is calibrated according to Linshang standard.





JJG 879-2015 (国标): The meter is calibrated according to Chinese standard.

Short press the " button to confirm the setting and the meter enters the measurement mode.

3. Measurement mode



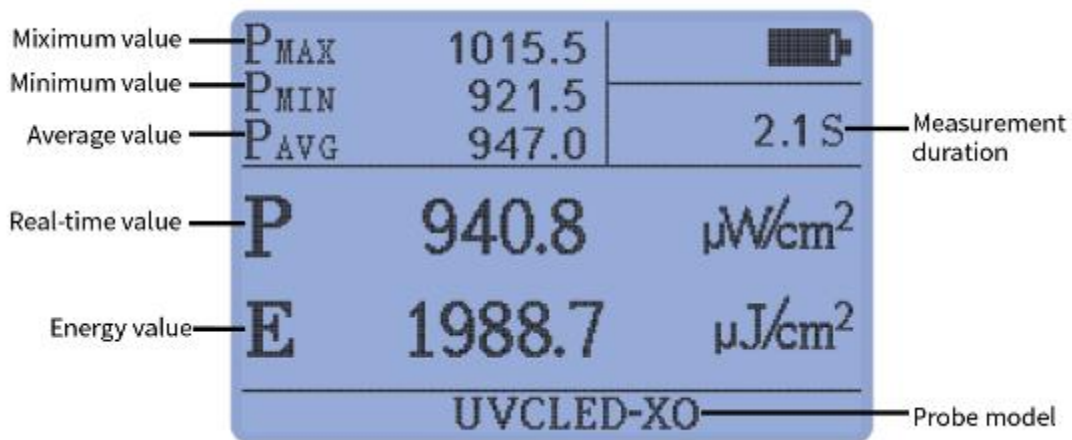

- In the measurement mode. The system displays the real-time value, maximum value, minimum value, average value, measurement duration, energy value (energy display = YES)
- In the measurement mode, if the backlight is off, press the " button to light the backlight; if the backlight is already lit, short press the " button, and the "HOLD" icon will be displayed in the lower left corner of the interface. All data will be kept on the LCD, and the current data will be saved to the history record.
- In the "HOLD" state, if the backlight is off, short press the " button to light the backlight; if the

backlight is already lit, short press the “” button to cancel the HOLD state and start a new measurement.

- In the measurement mode, if the backlight is off, short press the “” button to light the backlight; if the backlight is already lit, press the “” button to clear up the current data and start a new measurement.
- In the measurement mode, short press “” or “” to enter the record data query mode.



4. Record data query mode

- Short press “” or “” to scroll up or down a record data.
No.1 is the latest recorded data (up to 9 records can be stored, and the oldest record will be deleted automatically when exceed 9 recorded data).
- Long press the “” button 3Second to clear all recorded data.
- Short press the “” button to enter the measurement mode.

5. Aviation plug connection

When plugging out the probe, make sure not to violently rotate and pull the connector, but plug out the plug by the way as shown in the following diagram.

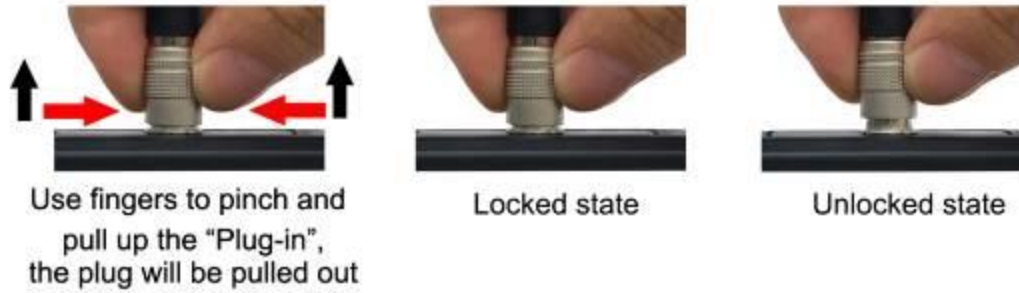

VI. Precautions

1. When not in use, please long press the  to power off the instrument.
2. Avoid contacting with corrosive materials and keep away from high humidity.
3. After shutdown, store it in a special packing box and keep it in a safe place. Protect the photosensitive part of the probe from polluting.
4. The recommended period of calibration is one year.
5. When the instrument is equipped with UVCLED-X0, UVALED-X0, UVALED-X1, UVALED-X3 probes, if it is necessary to obtain the calibration certificate of the National Institute of Metrology, it is necessary to send it to the South China Institute of Metrology for testing, and before sending it for testing, set the "Standard Selection" option of the instrument to "JJG 879-2015 (国标)".
6. Because the UV probe is sensitive to humidity changes, the environment in which it is stored is important. When not in use for a long time, be sure to store the instrument in a low humidity environment.
7. When the instrument displays low battery, replace the battery.

VII. Packing list

No.	Description	Quantity	Unit
1	UV Light Meter	1	pcs
2	Probe	According to the numbers of probe ordered	
3	AAA battery	4	pcs
4	User manual	1	pcs
5	Calibration Report	1	pcs
6	Certificate/Warranty card	1	pcs



7	Plastic box	1	pcs
---	-------------	---	-----

VIII. Service

1. The instrument has one-year warranty. If the instrument works abnormally, please send the whole instrument to our company for maintenance
2. Provide users with spare parts and lifelong maintenance services
3. Provide the users with the meter calibration service
4. Free technical support for long term

Manufacturer: Shenzhen Linshang Technology Co., Ltd.

Website www.linshangtech.com

Service hotline: 086-755-86263411

Email: sales21@linshangtech.com