

LS153

Vacuum Coating Thickness

Measuring System

User Manual V1.03

Applicable to on-line quality monitoring of roll coating machine, coating machine and glass production line
Optical density value (OD value) online detection
Light transmittance online detection
Detect coating thickness with optical principle

26080153

Table of contents

Part I. LS153 Introduction	4
I. Hardware Composition: Console and HMI Control Box.....	4
II. LS153 Characteristics	4
III. LS153 Internal Structure.....	5
IV. Parameters.....	5
V. Application Cases	6
Case 1.....	6
Case 2.....	6
Part II. LS153 Hardware User Manual	7
I. Introduction and Characteristics	7
II. Parameters.....	8
III. Structure and Composition	9
1. Software Composition	9
2. Hardware Composition.....	9
3. Control Console Structure	9
4. HMI Control Box Structure.....	10
IV. Installation Instructions.....	10
1. Control Console Installation	10
2. HMI Control Box Installation.....	10
3. Connection of Communication Line and Power Line	11
V. Operation	13
VI. Maintenance and Precautions	13
VII. Abnormal Handling	14
1. Abnormal Communication Description	14
2. Abnormal Calibration Description.....	14
3. Abnormal Probe Description	15
VIII. Internal Composition of Control Console.....	15
1. Internal Structure of Control Console.....	15
2. Probe	16
3. Aviation Connector.....	18
IX. Factory List.....	18
X. After-Sales Service	18
Part III. LS153 HMI Software User Manual	20
I. Operation Interface Description.....	20
1. Real-time Monitoring	21
2. Histogram.....	25
3. User Setting	29
4. Manual Calibration.....	36
5. Communication Configuration.....	39
6. System State	41
7. System Configuration	43
8. Communication Test	43



II. Description of Common Abnormity.....	44
1. Communication Abnormal Description.....	44
2. Calibration Abnormal Description	45
3. Probe Abnormal Description.....	45

Part I. LS153 Introduction

I. Hardware Composition: Console and HMI Control Box

1. The control console consist the light source probe, receiving probe, terminal box and aluminum profile bracket.
2. The human-machine interface control box consist the human-machine interface, power supply and stainless box.

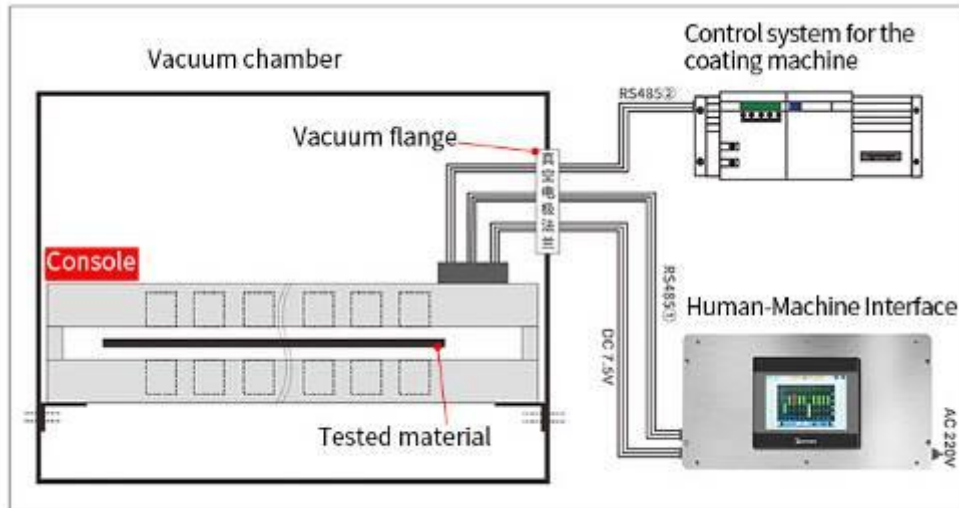

II. LS153 Characteristics

1. The ultra-small digital probe, which is easy to use and install. The device only needs to connect 6 wires.
2. The coating thickness measuring system perform optical non-contact measurement which has no direct contact with the test material.
3. The device has high measurement accuracy and can be comparable to American NAGY online thickness measurement equipment
4. With modular design, the single point is removable for easy maintenance
5. Dust-proof design, dust does not affect the inside of the probe, we just need to clean the front glass of the probe
6. RS485 interface + MODBUS communication protocol, the device can communicate with coating machine to realize closed-loop control
7. Cross-line alarm function, the device can control production quality, reduce dependence on personnel, improve production efficiency and quality

III. LS153 Internal Structure

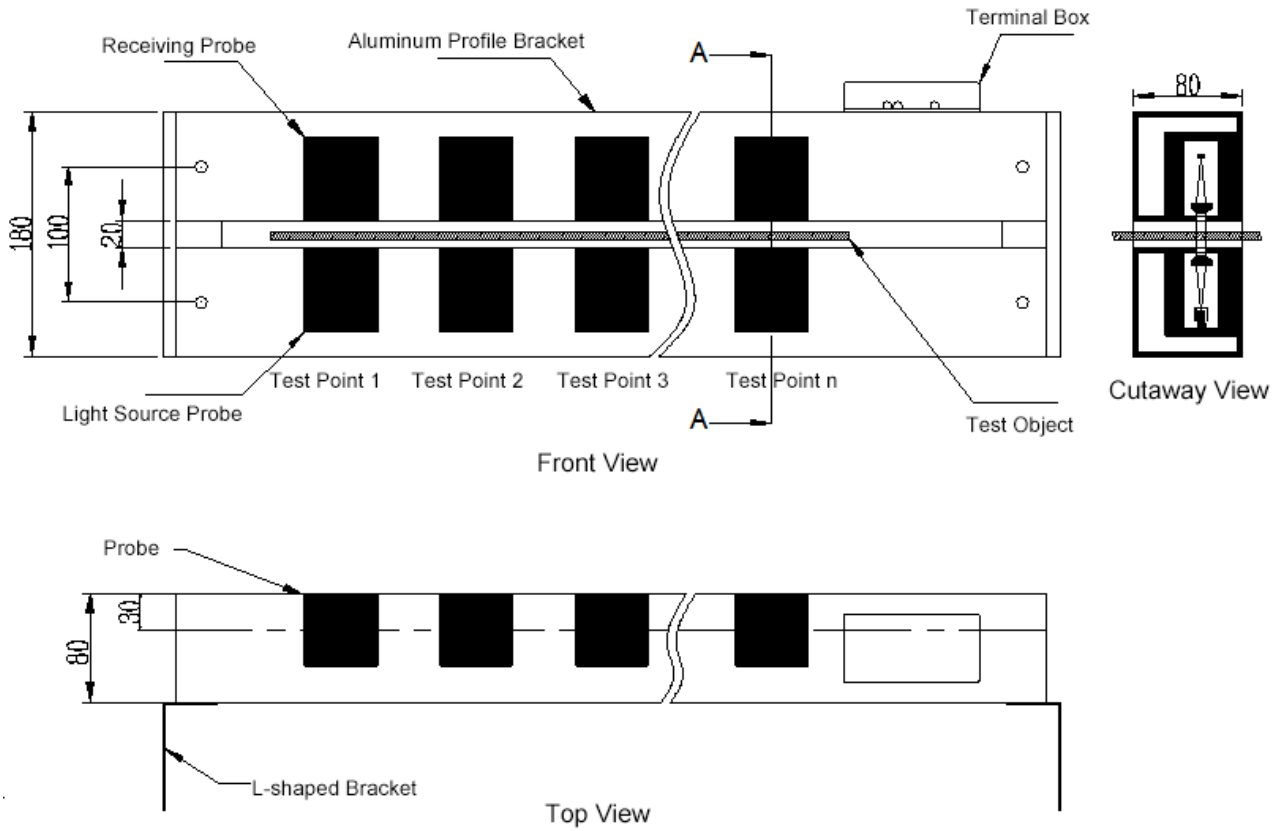

IV. Parameters

Parameters	LS153
Test wavelength (optional)	Infrared: 850nm, Green light: 530nm (optional)
Transmittance measurement accuracy	Better than $\pm 1\%$
Transmittance resolution	0.005%
Optical density measurement range	0.00 OD - 6.00 OD
Optical density resolution	0.01 OD for 0.00-3.00 OD 0.05 OD for 3.00-5.00 OD 0.15 OD for 5.00-6.00 OD
Data refresh cycle	300ms
Communication interface	Dual RS485

Communication protocol	MODBUS protocol
Vacuum flange electrode cores	6 (RS485①+DC7.5V) 9 (RS485①+ RS485②+DC7.5V)
Supply Voltage	220V AC/50Hz
Operating Current	0.2A
Operating Power Consumption	40W

V. Application Cases

Case 1

Gaotai gold foil customized 1 set of coating thickness measuring system with 9 points. The device use diffuse transmission principle. It can test the coating thickness uniformity on both transparent and matte, opalescent materials.



Case 2

Ulvac Vaccum enterprise customized one set of coating thickness measuring system with 12 points which is longer than 3 meters. The device consist 12 test points, there are two RS485 output lines, one is output to the human-machine interface, and the other is connected with the PLC for communication to achive closed-loop control.



Part II. LS153 Hardware User Manual

I. Introduction and Characteristics

The vertical and horizontal uniformity of the coating thickness are important quality and technical indicators of the coated products. The optical density (optical density = $\text{Log}(1 / \text{transmittance})$) of the coated product is proportional to the coating thickness. If the coating thickness is thicker, the optical density value will be larger and the transmittance value will be lower. Therefore, the coating thickness can be monitored by measuring the optical density value of the coating product.

Vacuum coating online thickness measuring system is suitable for various coating and coating production lines. It can monitor and analyze product coating thickness online by monitoring the product's optical density value (OD). Measure the thickness of the product coating online to understand and monitor the product quality in time during the production process. If there is a problem, users can find and adjust the process parameters early to improve the product quality and reduce the reject rate of the product. LS153 vacuum coating thickness measuring system is widely used in roll vacuum coating, glass coating, glass production line, coating production line, etc. The equipment has the following characteristics:

- Independent digital probe design makes the equipment very easy to install and use.
- Modular design, the modules are connected by aviation connectors, the structure is simple. The on-site installation and maintenance are convenient.
- The device has a temperature compensation function and stable values, allowing use in high temperature environments.
- Dust-proof design. The dust during the coating process (such as the aluminum plating process) will affect the measurement optical system. If there is dust, you only need to periodically clean the lens glass of the light source probe and the receiving probe, which is convenient for maintenance.
- This device provides dual RS485 communication interface and standard MODBUS communication protocol, which is convenient for communication with PLC, single-chip computer, human-machine interface, Kingview, computer and so on. The coating machine can directly read the optical density data of this equipment and realize the control automation (closed loop control).
- Human-machine interface, real-time monitoring of all test point data, including real-time display, histogram, upper and lower threshold setting, limit violation alarm, RS485② communication parameter setting, etc. The transmittance and optical density display can be switched freely.
- The device has automatic calibration function and manual calibration function, users can freely set according to their needs.

Standards for the product

JJF 1225-2009 Calibration Specification for Transmittance Meter of Automobile

JJG 178-2007 Ultraviolet, Visible, Near-Infrared Spectrophotometers

II. Parameters

Parameters	LS153
Test wavelength (optional)	Green light: 530nm, Infrared: 850nm
Measuring spot	5mm (diameter)
Transmittance measurement accuracy	Better than $\pm 1\%$
Transmittance resolution	0.005%
Optical density measurement range	0.00 OD - 6.00 OD
Optical density resolution	0.01 OD for 0.00-3.00 OD 0.05 OD for 3.00-5.00 OD 0.15 OD for 5.00-6.00 OD
Maximum measurement points	45points
Distance between adjacent probe	Minimum distance of 35mm
Distance between receiving probe and light source probe	20mm
Temperature range	-10°C - 60°C
Storage temperature	-20°C - 70°C
Relative humidity	less than 85%, no condensation
Data refresh cycle	Normal mode 300ms/ Fast mode 100ms
Communication interface	Dual RS485
Communication protocol	MODBUS protocol
Dimension	80mm(W)*180mm(H)*L (Customized)
Vacuum flange electrode cores	6 ((without computer monitoring software 9 (with computer monitoring software)
Power supply	220V AC/50Hz

III. Structure and Composition

1. Software Composition

The software includes human-machine interface monitoring software (standard) and computer real-time monitoring software (optional).

- 1) Human-machine interface monitoring software, real-time monitoring of all test point data, including real-time display, histogram, upper and lower threshold settings, manual calibration, limit violation alarm, etc. The transmittance and optical density display can be switched freely.
- 2) Real-time computer monitoring software, real-time monitoring of all test point data, including real-time display, histogram, upper and lower threshold settings, real-time curve, limit violation alarm and real-time storage of monitoring data.

2. Hardware Composition

The hardware of the device is mainly composed of two parts: "Human Machine Interface Control Box" and "Control Console".

- 1) The control console mainly includes: a light source probe, a receiving probe, terminal box and an aluminum profile frame.
- 2) Human-machine interface control box mainly includes: human-machine interface, power supply, stainless steel box.

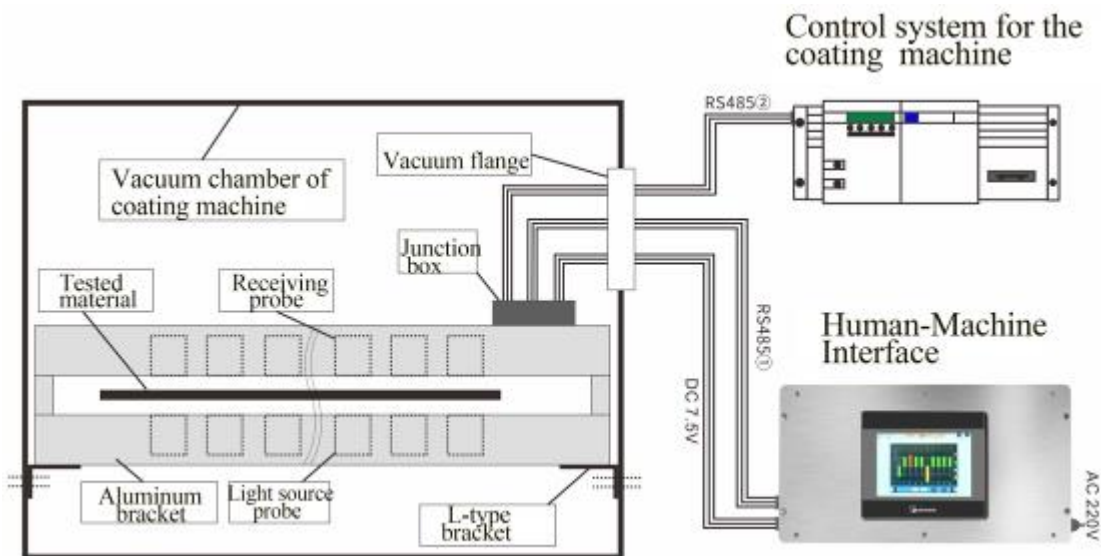

3. Control Console Structure

The structure of LS153 control console is shown in the figure below. The unit is mm. (The test points are different, but they are different in the length direction of the device, there is no change in the height and width directions).

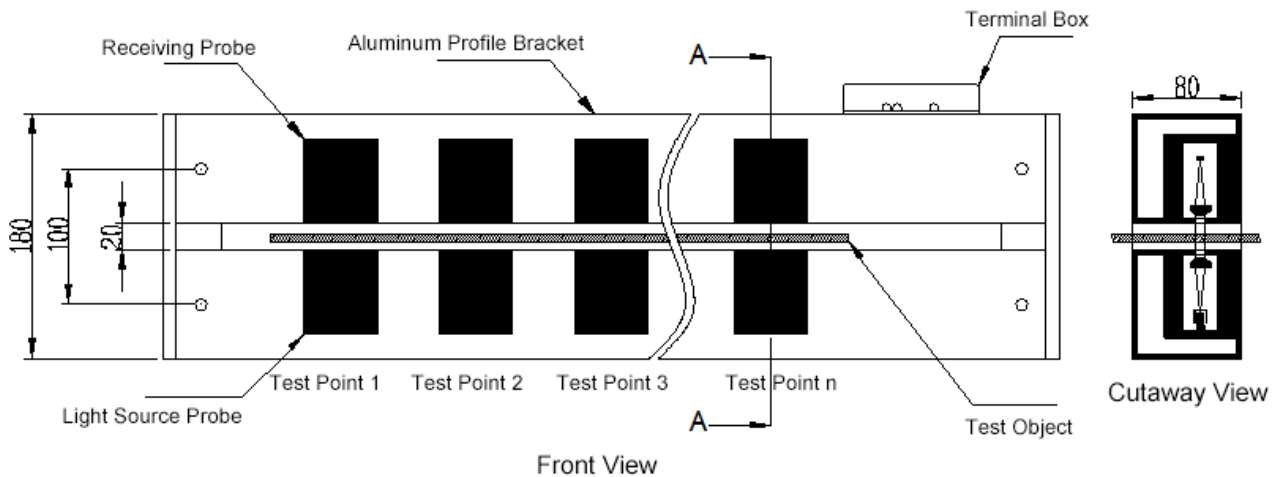

Figure 3.1 Control console structure schematic drawing

4. HMI Control Box Structure

LS153 human-machine interface control box has 3 modes for users to choose from: embedded, wall-mounted and desktop. We will provide detailed drawings for confirmation when ordering.

IV. Installation Instructions

The control console is installed in the vacuum chamber and the human-machine interface control box is installed outside the vacuum chamber. The communication line and the power supply line of the control console are connected through the vacuum electrode flange.

1. Control Console Installation

The control console is installed in the vacuum chamber of the coating machine. First fix the L-shaped fixing bracket on the two walls of the vacuum chamber and then lock the control console to the L-shaped fixing bracket with M8 screw.

2. HMI Control Box Installation

The human-machine interface control box provides three installation methods. The user can choose one of them according to the site requirements.

- 1) Embedded: The human-machine interface control box is embedded in the coating machine console for use.
- 2) Wall-mounted: HMI control box is installed on the wall for use.
- 3) Desktop: HMI control box is placed on the desktop for use.

3. Connection of Communication Line and Power Line

(1) Connection between control console and HMI control box

- A. The DC 7.5V of the control console is connected to the DC 7.5V of the HMI control box.
- B. The control console RS485① must be connected with the human-machine interface control box RS485①.
- C. RS485② is used for communication between control console and PLC, computer and other equipment.

The LS153 control console has a total of 3 wiring ports, which are 7.5V power, RS485①, RS485②. The interface is at the junction box of the control console. When wiring, first unscrew the 4 screws on the terminal box cover and remove the terminal box cover to see 3 terminal ports.



LS153 human-machine interface control box has 3 wiring ports, which are 7.5V power supply, RS485①, alarm light. The interface is located on the left side of the control box (wall-mounted) or on the back of the control box (embedded and desktop). The interface is shown below:

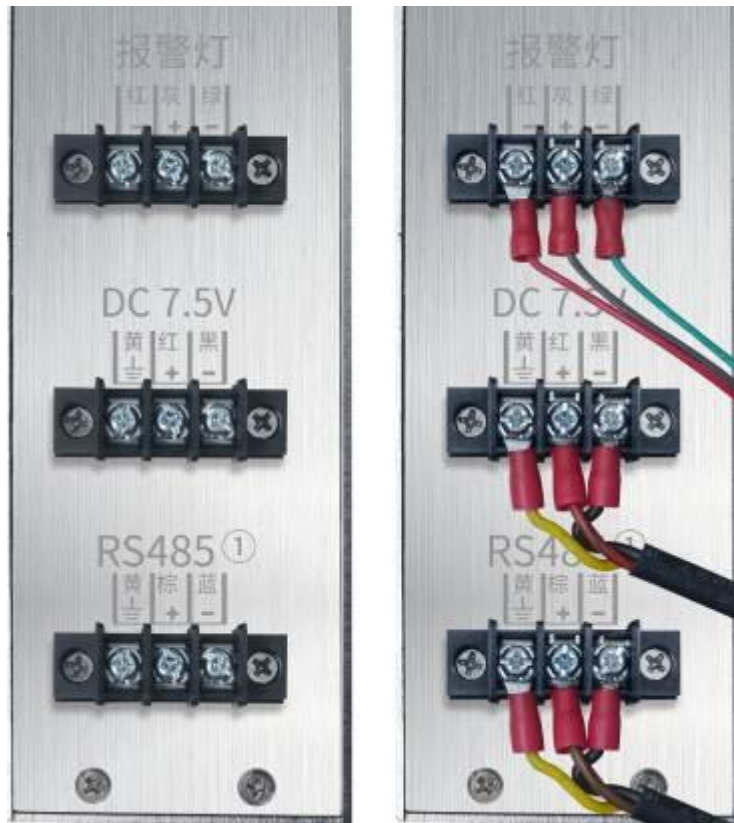

Unwired Control Box

Wired Control Box

The connecting wires used in the equipment conform to the national standard. The wires and wiring methods used are as follows:

Power cord model: RVV 3 * 0.75mm², three-core unshielded, black; inner core color corresponds to DC7.5V wiring port:

Power cord type	Inner core color	Terminal block label
RVV 3*0.75 mm ²	Red	DC7.5V +
	Black	DC7.5V -
	Yellow	DC7.5V 

Communication line model: RVVSP 2 * 0.5mm², shielded twisted pair, black. Inner core color corresponds to RS485 wiring port:

Communication line type	Wire core color	Terminal block label
RVVSP 2*0.5mm ²	Brown	RS485 +
	Blue	RS485 -
	Yellow	

(2) Alarm light connection

The alarm light interface is located on the left side of the control box (wall-mounted) or on the back of the control box (embedded and desktop). The alarm light interface provides a 24V signal. Please connect with the alarm light provided with the device. The color of the alarm light wire corresponds to the connection port:

Alarm light wire color	Terminal block label
Red	Alarm light Red-
Gray	Alarm light Gray+
Green	Alarm light Green-

For alarm light setting, please refer to "[User Settings](#)" in "[LS153 HMI Software User Manual](#)" for operation.

(3) Human-machine interface control box power supply

The human-machine interface control box is connected to AC 220V mains power. The interface is located on the right side of the control box (wall-mounted) or on the back of the control box (embedded and desktop). The power supply uses a three-pin computer power cable.

V. Operation

After the device is installed, check that the wiring is correct. Turn on the power. After a few seconds, the display interface of Human-machine interface will appear.

Note: When the device is turned on in the self-calibration mode, please don't place anything between the light source probe and the receiving probe. Otherwise, self-calibration cannot be completed. The test data appears will be inaccurate or wrong.

If the film has been installed, open a hole on the film where the light source receives the probe. By doing this, the emitted light can pass through without blocking. The automatic calibration function can also be completed.

If the device operates in manual mode, it is not subject to this limitation.

- 1) Please refer to "[LS153 HMI Software User Manual](#)" for Human-machine Interface operation.
- 2) If the device is connected to PLC, Kingview, etc., please refer to "[LS153 Vacuum Coating Thickness Measuring System Communication Protocol](#)".

VI. Maintenance and Precautions

1. Optical components are highly sensitive devices. The lens glass at the front of the probe should always be kept clean. Periodically use a clean soft cloth and alcohol to wipe off aluminum ash and other pollutants.

2. This device measures the thickness and uniformity of the material coating by measuring the optical transmittance or optical density of the material (such as plastic film, glass, etc.). The measured results do not directly show the thickness of the material, but rather the optical density or transmittance of the material.
3. The measuring function of this device is realized by optical method, non-contact measurement. The measurement will cause no damage to the film.
4. The control console can install multiple sets of probes side by side. The minimum distance between each set of probes can reach about 35mm.
5. The probe adopts a plug-in design and connected by the aviation connector. The user can install, remove and replace the probe by himself, which is convenient for maintenance.
6. The working temperature of the device is $-10\text{ }^{\circ}\text{C}$ - $60\text{ }^{\circ}\text{C}$, the relative humidity should be less than 85% and no condensation is generated.
7. The storage temperature of the device is $-20\text{ }^{\circ}\text{C}$ - $70\text{ }^{\circ}\text{C}$. It should be stored in a dry place away from heat sources and corrosives.
8. The use of this device should avoid strong electromagnetic interference.

VII. Abnormal Handling

1. Abnormal Communication Description

After powering on, when the communication indicator in the upper left corner of the display unit is gray, the calibration indicator is red and the temperature display has no measured value. You should enter the "System Status" interface to see more details.

If all test point are abnormal, it means that the display unit communication is abnormal. Generally there are three reasons for communication abnormality:

- 1) The power supply of the "Control console" is abnormal. Check whether the 7.5V power cord of the "Control console" and the "Human Machine Interface Control Box" are properly connected. Use a multimeter to measure whether the interface voltage is 7.5V and whether the power supply is connected in the opposite direction.
- 2) The communication cable is incorrectly connected. Check whether the RS485① communication cable of the "Control console" and the "Human Machine Interface Control Box" is connected correctly.
- 3) The receiving probe is damaged and needs to be returned to the factory for repair.

If only some test points have abnormal communication, the corresponding probe is damaged. The device needs to be returned to the factory for repair.

2. Abnormal Calibration Description

When the calibration indicator in the upper left corner of the HMI is red, it indicates that the device is abnormally calibrated. At this time, the user should enter the "System Status" interface to check which

point is abnormal. Generally, the calibration status is abnormal for the following four reasons:

- 1) The light path is blocked by dust. Wipe the lens glass at the corresponding point with a dust-free cloth.
- 2) In the auto-calibration state, there is a sample in the test slot when the machine is turned on.
- 3) During manual calibration, the manual calibration value is significantly different from the standard value of the calibration plate.
- 4) The light source is permanently damaged, please send it back to the factory for repair.

3. Abnormal Probe Description

1. When the measured value transmittance of the test point on the human-machine interface always shows "11.1100" or the measured value of the optical density always shows "0.9543", this phenomenon is the same regardless of whether there is a test object or after restarting. It indicates that the light source probe or receiving probe of the test point is faulty, the set of probes(receiving probe and light source probe) needs to be returned to the factory for inspection and maintenance.
2. When the measured value transmittance of the test point on the human-machine interface keeps showing "88.8800" or the measured value of optical density always shows "0.0512", whether the test object is present or after restarting, the above phenomenon still exists. It indicates that that no data was collected at this test point, the set of probes(receiving probe and light source probe) needs to be returned to the factory for inspection and maintenance..
3. When the temperature on the human-machine interface keeps displaying "88.8". Or in the "System Status" interface, the temperature of the probe always displays "88.8", indicating that the temperature sensors of the receiving probe is damaged. You can send the corresponding receiving probe to the factory for repair.

VIII. Internal Composition of Control Console

1. Internal Structure of Control Console

LS153 vacuum coating thickness measuring system control console installed multiple sets of probes side by side, each set of probes includes a light source probe and a receiving probe, the numbering of the probes starts from 1 and sequentially increases.

Inside the device, the probes have been connected through the aviation connector. The following figure shows the internal connection of the control console.

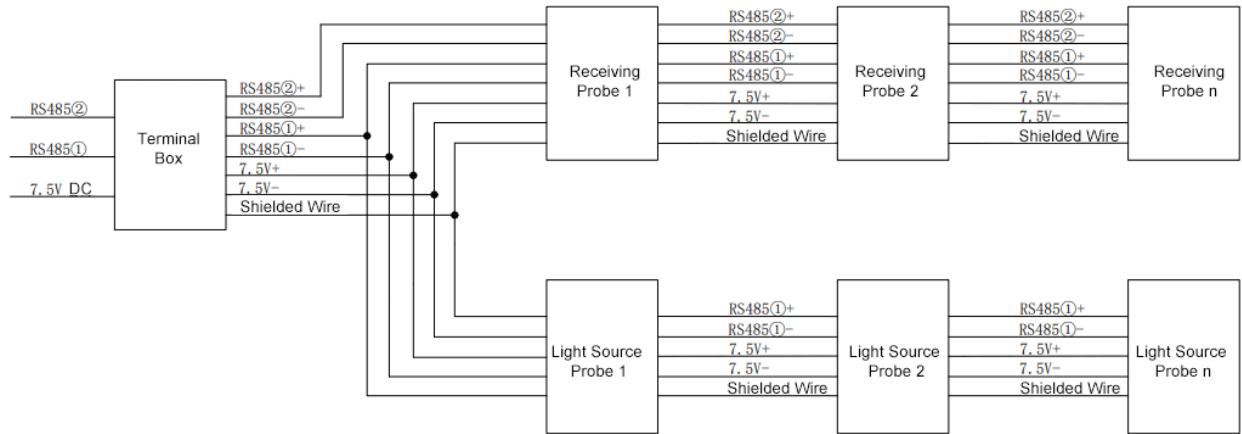

Figure 8.1 Control console internal structure connection

2. Probe

The identification at the top of the probe is shown in the figure below. The identification PD represents the receiving probe, LED represents the light source probe, ①②③ represents the test point number and the SN number is the unique number of the device.

If a certain set of probes of the equipment fails, the user can remove and replace the corresponding probes by themselves (please contact the manufacturer before disassembly). The aviation connector uses a plug-in design, the plug has a spring limit. The plug of the connector cannot be pulled by force.

The light source probe and the receiving probe have the same mounting holes. There are 6 screw holes on the front of the probe and 4 screw holes on the bottom (light hole surface). The user can choose the appropriate mounting hole according to the site.

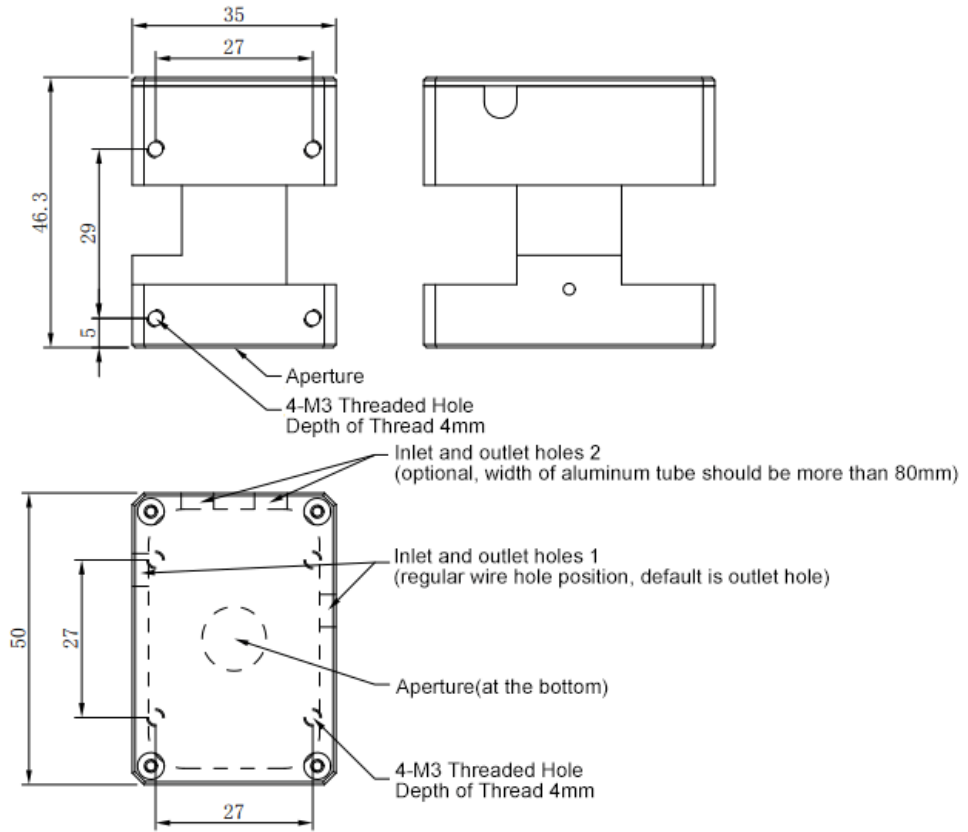

Figure 8.2 Light source probe dimension

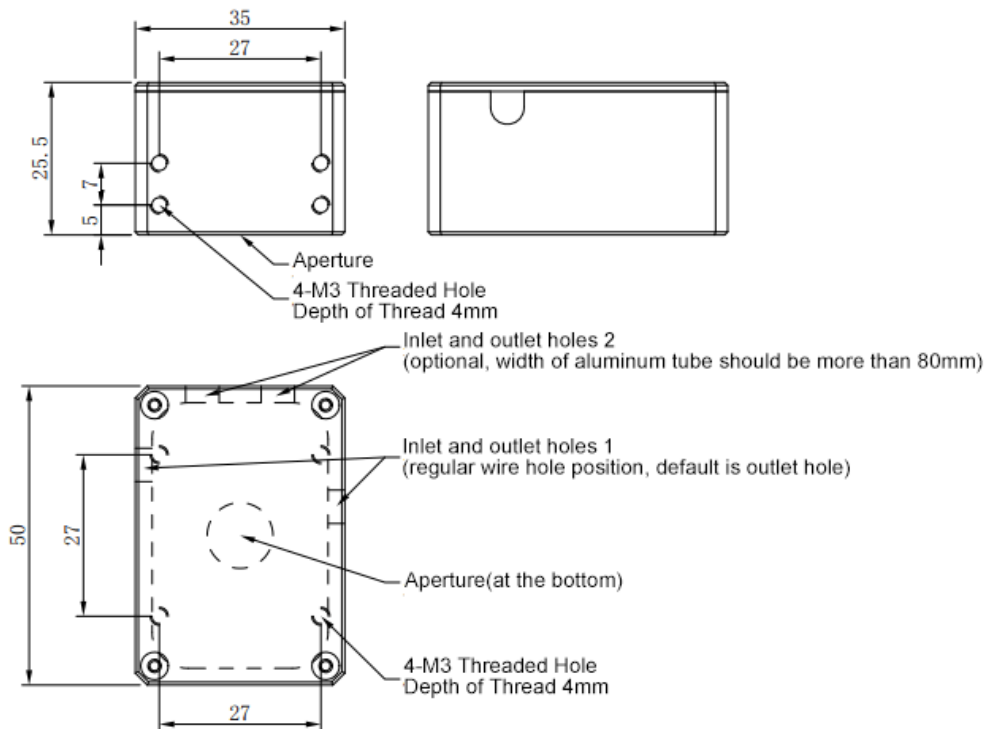

Figure 8.3 Receiving source probe dimension

3. Aviation Connector

The aluminum profile frame of the measurement and control console is composed of two aluminum profiles, one for the light source probe and the other for the receiving probe and the terminal box.

When connecting the light source probe and the receiving probe to terminal box, pay attention to the label and its color. The light source probe is white and the receiving probe is blue. When the aviation plug is connected, pay attention to the color and number of the label.

The LS153 vacuum coating thickness measuring system uses 2 types of aviation connectors: 7-pin connector and 5-pin connector. Two types of connectors connect different modules to prevent connection errors. As shown in the table below.

Aviation connector	Use	Remarks
7-pin	Receiving probe to receiving probe connection	Receiving probe is a male and a female two-terminal outlet
5-pin	Light source probe to light source probe connection	Light source probe is a male and a female two-terminal outlet

Table 8.1 Aviation connector applications

IX. Factory List

Items	Quantity	Unit
Control console	1	pcs
HMI control box	1	pcs
L-shaped fixing brackets	2	pcs
Fixed screw M8 * 90 and accessories	4	pcs
Standard board	1	pcs
Factory report	1	pcs
User manual	1	pcs

X. After-Sales Service

1. The warranty period is one year. If the device fails, please send the entire device or the damaged probe to the manufacturer for repair
2. Provide users with spare parts for a long time and provide life-long maintenance services



3. Provide users with free device inspection services
4. Free long-term technical support

Manufacturer: Shenzhen Linshang Technology Co., Ltd.

Website: www.linshangtech.com

Service Hotline: 0755-86263411

Email: sales21@linshangtech.com

Part III. LS153 HMI Software User Manual

I. Operation Interface Description

After the Human Machine Interface is turned on, it will enter the main interface as shown below:



Note: This manual uses 3 test points as an example.

The first  icon in the upper left corner of the main interface is the communication status indicator. When the light is on (green), the communication is normal. If the light is off (gray), the communication is abnormal. You can click the “System State” interface to check which set communication probes is not normal. Users can refer to the third section of this manual to solve the problem.

The second  icon in the upper left corner of the main interface is the calibration status indicator. If the indicator is green, the calibration of all the test points is normal. If the indicator is red, there is an abnormal calibration of the original value of the test point (if so, the test data of the point is not accurate). The inaccurate original value of the test point can be checked by clicking the “System State” button.

The “Temperature” in the upper left corner of the main interface shows the internal temperature when the “Control console” is working.

From the main interface, it can be seen that the Human Machine Interface contains 8 operable items: real-time monitoring, histogram, user setting, manual calibration, communication configuration, System State, system configuration and communication test. The respective operation items are described in detail below.



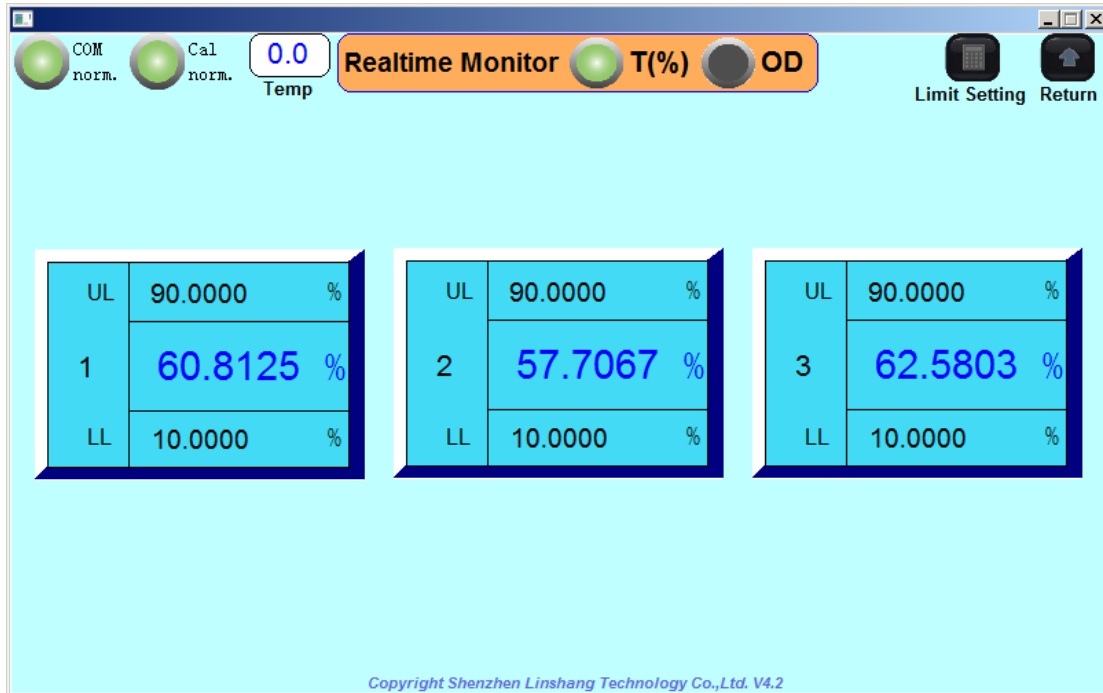

1. Real-time Monitoring

The following real-time monitoring interface will show by clicking the icon of “Real-time Monitoring”:



The function of real-time monitoring is to display real-time data of each test point conveniently.

Display methods include: transmittance display and optical density display

The display mode can be switched by clicking the  icon in  **T(%)**  **OD**; the  icon shows the current display mode. The optical density and transmittance display are one-to-one correspondence (*Note: $OD = \log_{10} (1/T)$ OD: Optical density T: transmittance*), Users can choose the appropriate display method according to their needs. The following two figures are the transmittance mode and the optical density mode.

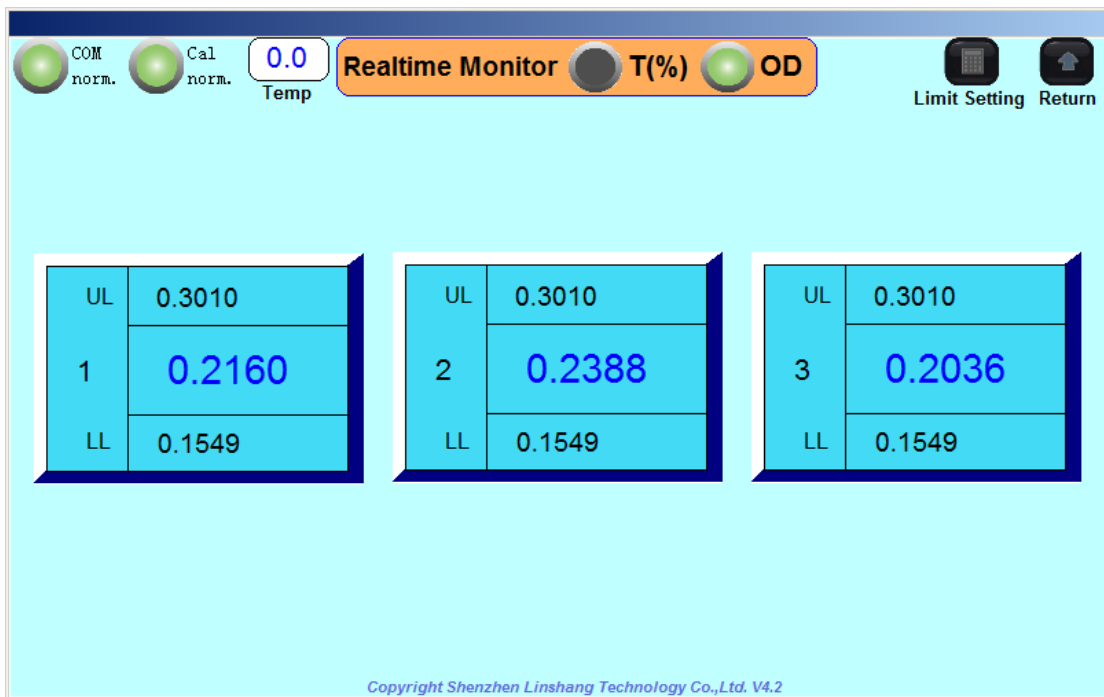
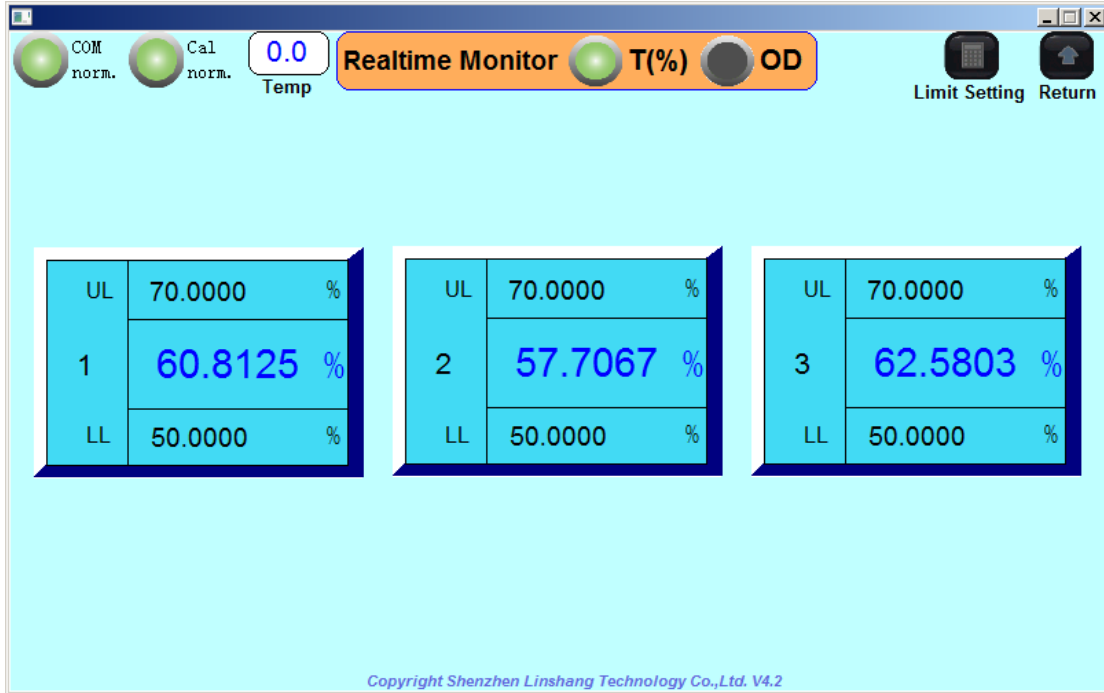

The displayed contents include: display point number, upper limit value, lower limit value and measured value

UL	90.0000	%	Upper limit
1	57.7067	%	Actual Value
LL	10.0000	%	Lower limit

The display point number and upper and lower limits are manually settable. The user can make display setup for the test point number according to the situation. Generally, the default is incremented from 1, and the display point number can be set through the “User Settings” interface. The upper and lower limits are referenced to the test object settings. The setting method can be set through the “User Settings” interface, and the “Limit Settings” icon in the upper right corner can also be clicked for quick setting. The detailed settings will be discussed later.

The value of the upper and lower limits is to specify the qualified judgment standard of the test object. After the upper and lower limits are set, if the measured value is less than the lower limit value, the measured value and the lower limit value become yellow, and the measured value flashes; if the measured value is greater than the upper limit value, the measured value and upper limit value become red, and the measured value flashes; if there is no communication, there is no measured value display.

Example 1: A test sample has a transmittance base value of 60%, an upper limit of 62%, and a lower limit of 58%. The test results are as follows:

The screenshot shows the 'Realtime Monitor' interface with the following data:

Test Point	UL (%)	Measured Value (%)	LL (%)
1	62.0000	60.8125	58.0000
2	62.0000	57.7067	58.0000
3	62.0000	62.5803	58.0000

Copyright Shenzhen Linshang Technology Co.,Ltd. V4.2

Test point 1 is qualified and the display color is blue;

Test point 2 is unqualified, the measured value is less than the lower limit value. So both the measured

value and the lower limit value are displayed in yellow, and the measured value will also flash;
 Test point 3 is unqualified, the measured value is greater than the upper limit value. For this reason both the measured value and the upper limit value are displayed in red, and the measured value will also flash.

Example 2: For a test sample with an optical density base value of 0.22, the upper limit is set to 0.23 and the lower limit is set to 0.21. The test results are as follows:

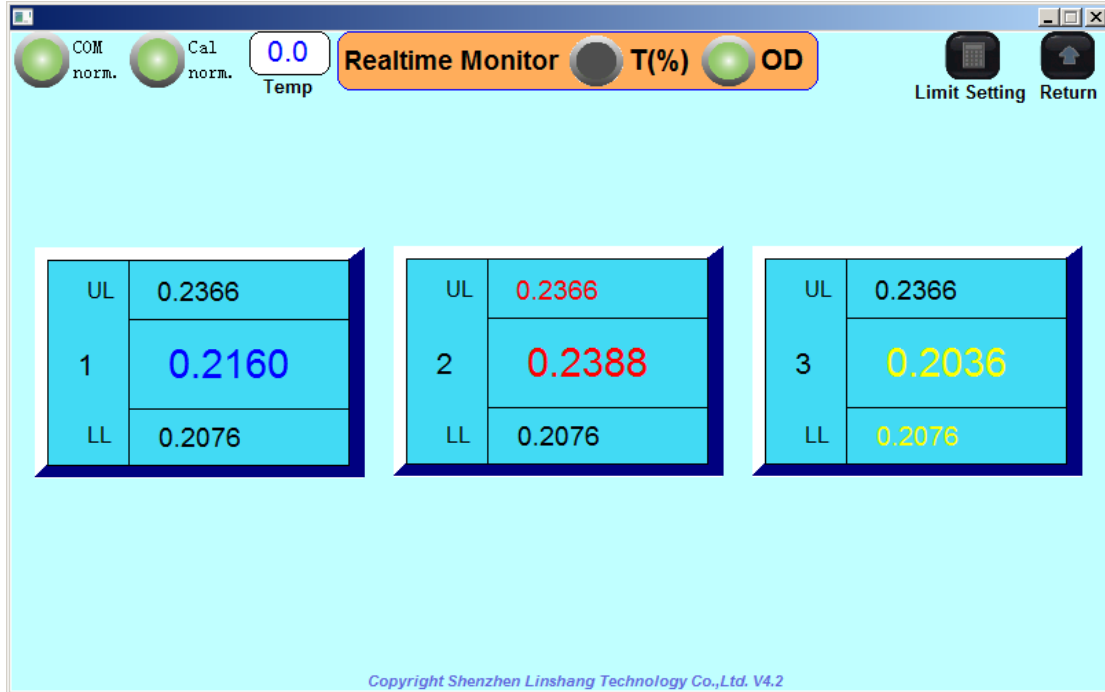

Test point 1 is qualified and the display color is blue;

Test point 2 is unqualified. The measured value is greater than the upper limit value, so both the measured value and the upper limit value are displayed in red, and the measured value will also flash;

Test point 3 is unqualified. The measured value is less than the lower limit value, so both the measured value and the lower limit value are displayed in yellow, and the measured value will also flash.

If the communication is abnormal, then there is no measured value display. The upper left corner indicator will show communication abnormality (gray). The calibration is abnormal (red), and there is no temperature value display. The result is as follows:

Transmittance display mode:

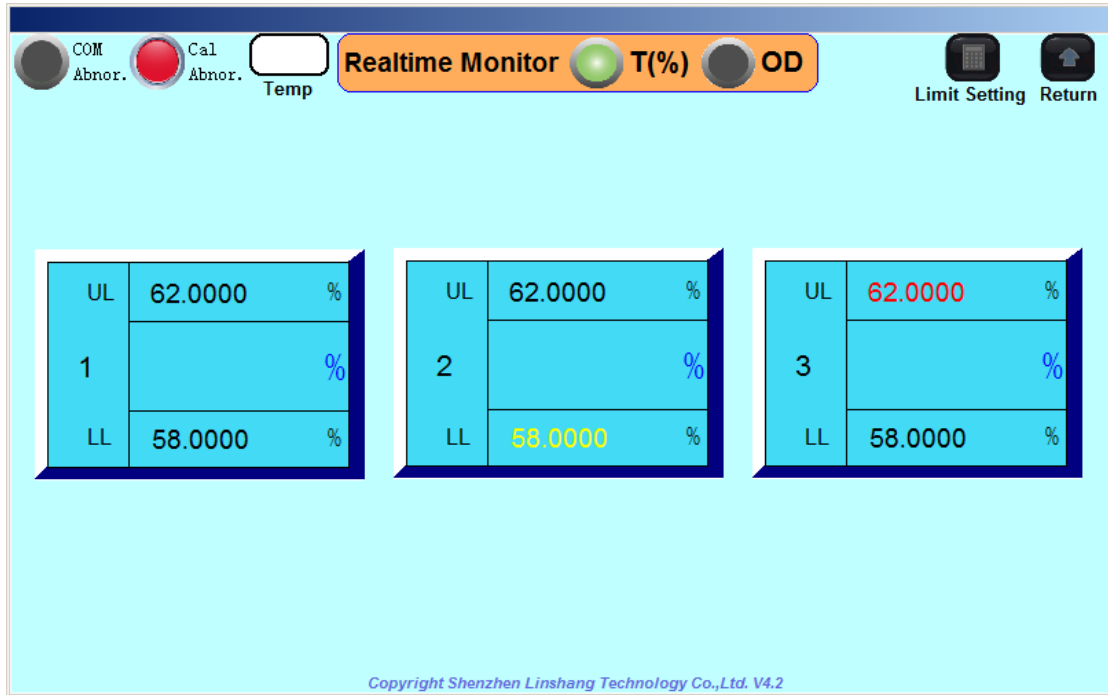

Optical density display interface:

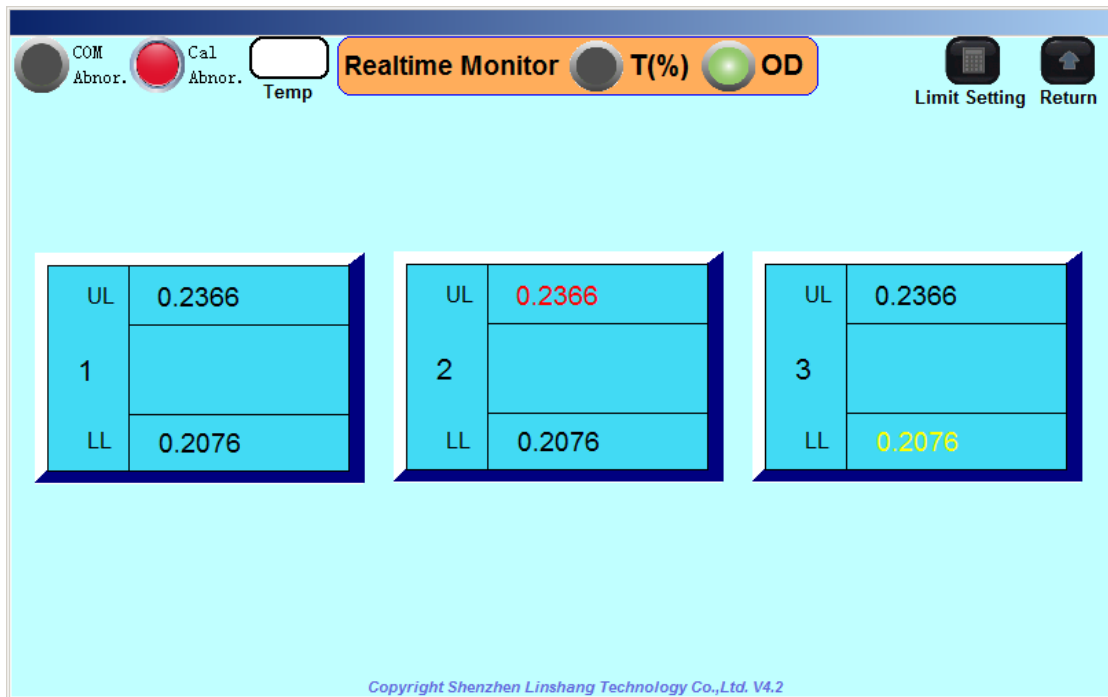

Click the "Return" icon in the upper right corner to return to the main interface (all of the following return icons are used to return to the main interface, which will not be explained later).

2. Histogram

Click on the "Histogram" icon to enter the interface of the histogram as shown below:

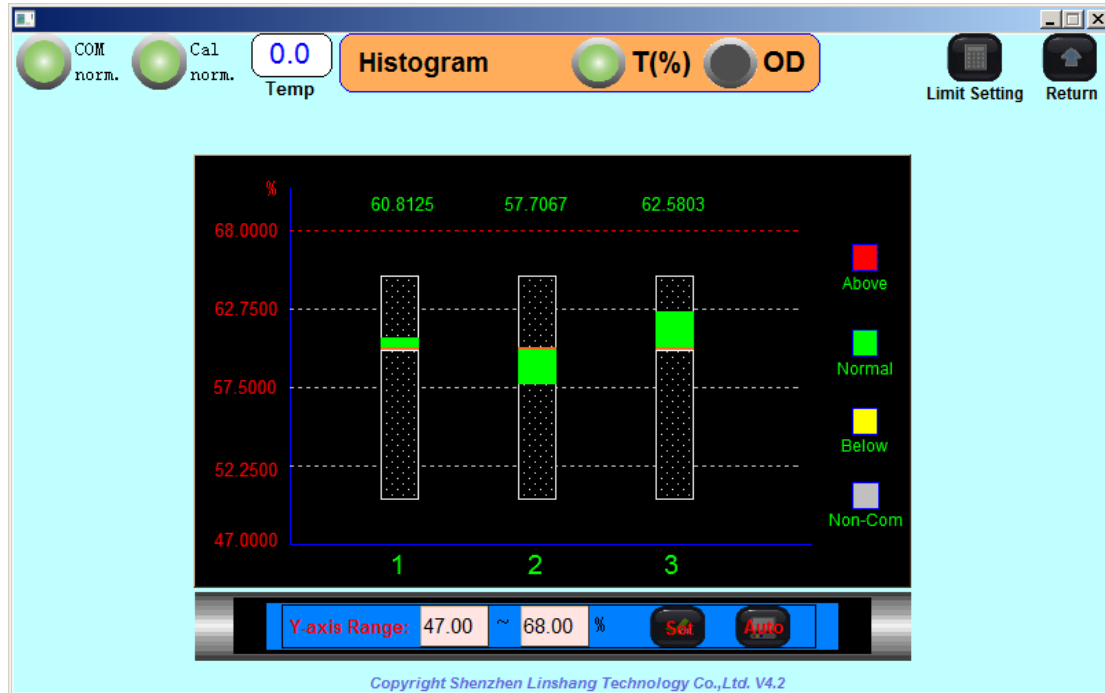

As shown above: rectangular box shows the upper and lower limits, and the filled chart shows the measured values.

The histogram display mode can visually express the difference between the test point and the base value.

The ordinate range is the coordinate range set for the display of histogram. After inputting the good coordinates in the input frame of the ordinate range (the transmittance display mode can be set to the range: 0-120; the optical density display mode can be set to the range: -0.3-6). Clicking the “Set” icon will be confirm. The user can also click the “Auto” icon directly. The device will adapt to the reasonable coordinate values according to the up and down values set by the user.

If the measured value is within the upper and lower limits, the histogram of the test point is green; if the measured value is greater than the upper limit set by the user, the histogram of the test point turns red; if the measured value is less than the lower limit value set by the user, the histogram of the test point turns yellow; if there is no communication, all histograms will turn gray.

Example 1: The base value of the transmittance of the test sample is 60%, the upper limit is set to 62%, and the lower limit is set to 58%. The test results are as follows:



The test point 1 is qualified, the histogram entity display color is green, and the top of the histogram is the measured value, which is also displayed in green;

Test point 2 is unqualified, the measured value is less than the lower limit value, so the histogram entity display color is yellow. The top of the histogram is the measured value, which is also shown as yellow, and the measured value will also flash;

Test point 3 is unqualified, the measured value is greater than the upper limit value, so the histogram entity display color is red, the top of the histogram is the measured value, which is also shown in red, and the measured value will also flash.

Example 2: For users who use optical density display, the optical density base value is 0.22. The upper limit is set to 0.23 and the lower limit is set to 0.21. The test results are as follows:



The test point 1 is qualified, the histogram entity display color is green, and the top of the histogram is the measured value, which is also displayed in green;

Test point 2 is unqualified, the measured value is greater than the upper limit value, so the histogram entity display color is red; the top of the histogram is the measured value, which is also shown in red, and the measured value will also flash;

Test point 3 is unqualified, the measured value is less than the lower limit value, so the histogram entity display color is yellow; the upper part of the histogram is the measured value, and it is also displayed in yellow, and the measured value will also flash.

If the communication is abnormal, then there is no measured value display, and the histogram is gray. The result is as follows:

Transmittance display mode:

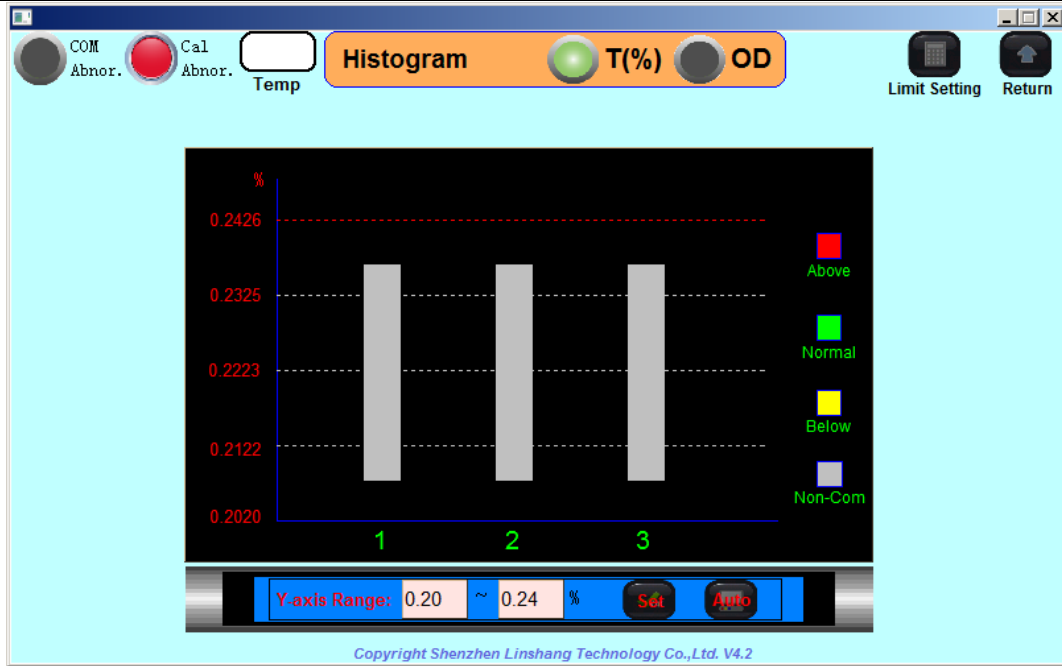

Optical density display mode:

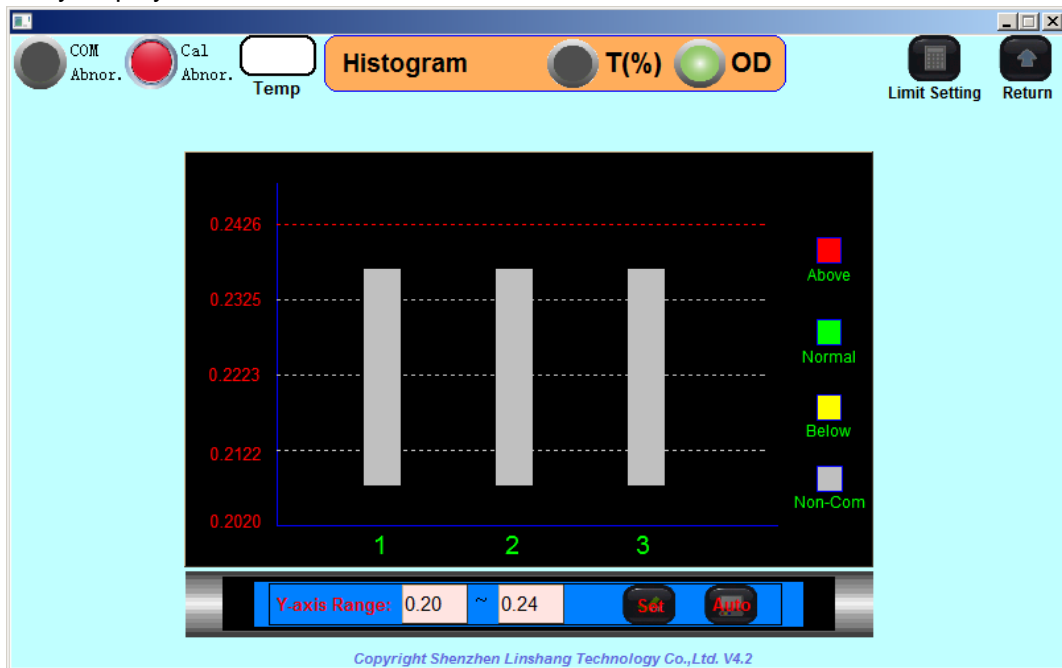

3. User Setting

Click the "User Setting" icon to enter the user setting interface as shown below:

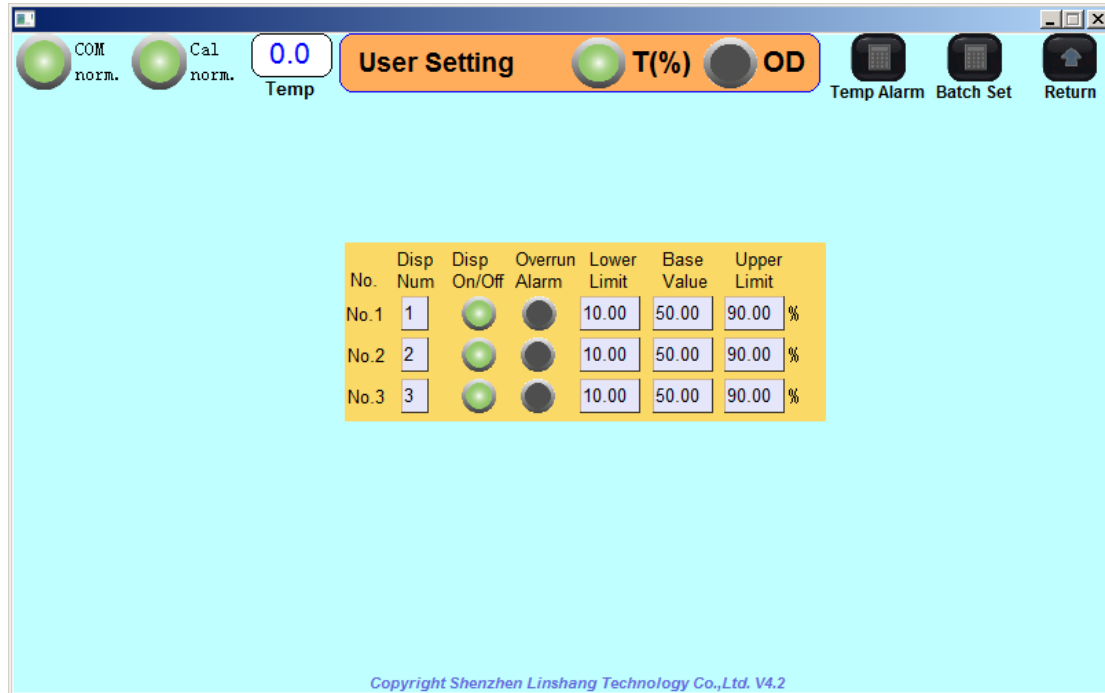

The user setting is an interface that provides the user with the upper and lower limits, the base value, the display point number, whether the test point is displayed, and whether the alarm function is on after the upper and lower limits are exceeded.

Upper limit: the qualified upper limit of the test object

Base value: the qualified reference value of the test object;

Lower limit: the qualified lower limit of the test object;

Displayed point number: that is the displayed number of the test point; the test point number is fixed inside the device as a natural number starting from 1 (No. 1, No. 2, No. 3...), and the fixed-point number is in the "Control console", and there are numerical values on it. However, in order to facilitate user use, the user can customize the test point number specifically for display. The default display point number is equal to the fixed test point number from 1 in the system.

Whether test point used: that is, whether the test point can be displayed in "real-time monitoring" and "histogram";

Over-limit alarm: it is possible to set whether an audible alarm will occur after the test point exceeds the limit value.

Alarm description: The alarm is divided into Human-machine Interface buzzer sound alarm and external alarm light sound and light alarm. The over-limit alarm can trigger Human Machine Interface buzzer alarm and external alarm light alarm (red light flashing) at the same time. Other alarms (communication abnormality, calibration abnormality, temperature over-limit) will only trigger the Human-machine Interface buzzer alarm.

Note: When setting the upper and lower limits and the base value, it needs to meet: lower limit \leq base value \leq upper limit

Users can choose the “Transmittance” or “Optical Density” display mode to set the parameters on the interface according to their own needs. If the settings of each test point are the same, the user can select batch setting to improve the efficiency. The user can click on the upper right corner. Clicking the “Batch Setting” icon will enter the batch setup interface.

Transmittance display mode:

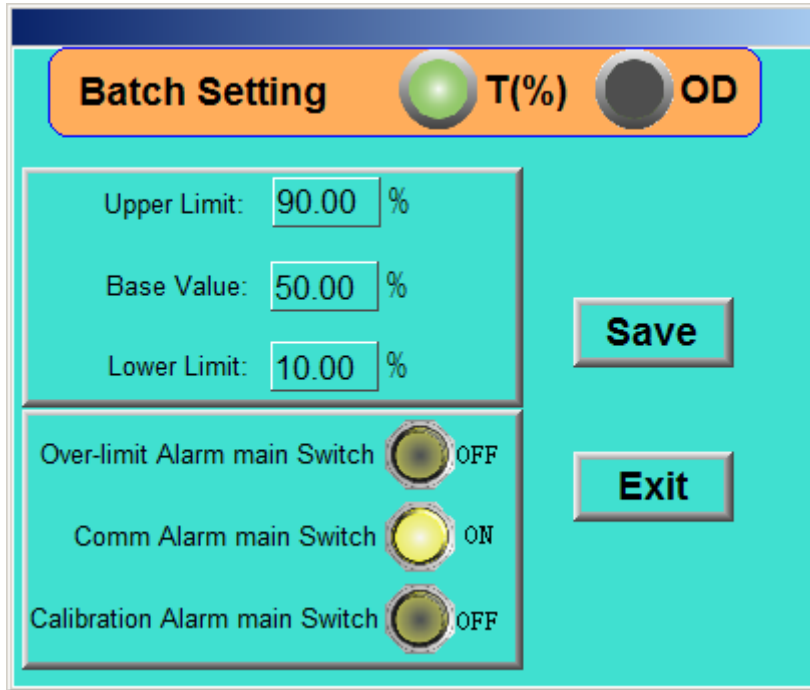

Optical density display mode:

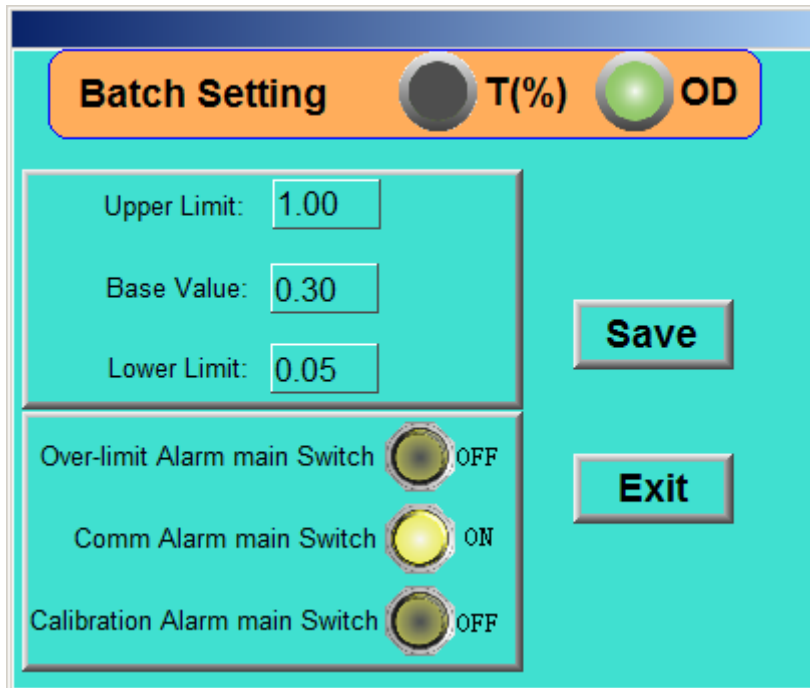

The user can set the upper and lower limits, the base value, the over limit alarm (whether or not the alarm

sound is emitted when the test point exceeds the upper and lower limits), the communication alarm (whether the alarm sound is generated when the communication is abnormal) and the calibration alarm (whether the alarm sound is generated when the calibration status is abnormal). After setting up, click the "Save" button and the "Exit" button.

Note: The "Limit Setting" of the real-time monitoring interface and the histogram interface is the same as the "Batch Setting" function here. Users can click the "Limit Setting" in these two interfaces without entering the user setting interface.

When the user exit the "User Settings" interface, the interface "Save Data or Not" will appear as shown below:

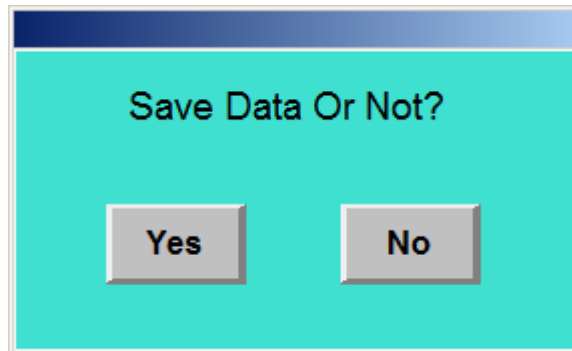

Click the "Yes" button to save the data that just been set. If the user click the "No" button, the data will not be saved and the data before the setting will be restored.

Example 1: The base value of the transmittance of the test sample is 60%, the upper limit is set to 62%, the lower limit is set to 58%, and the display points are points 4, 5, 6; Point 4 and point 6 display, and over-limit alarms are turned off, as shown below:

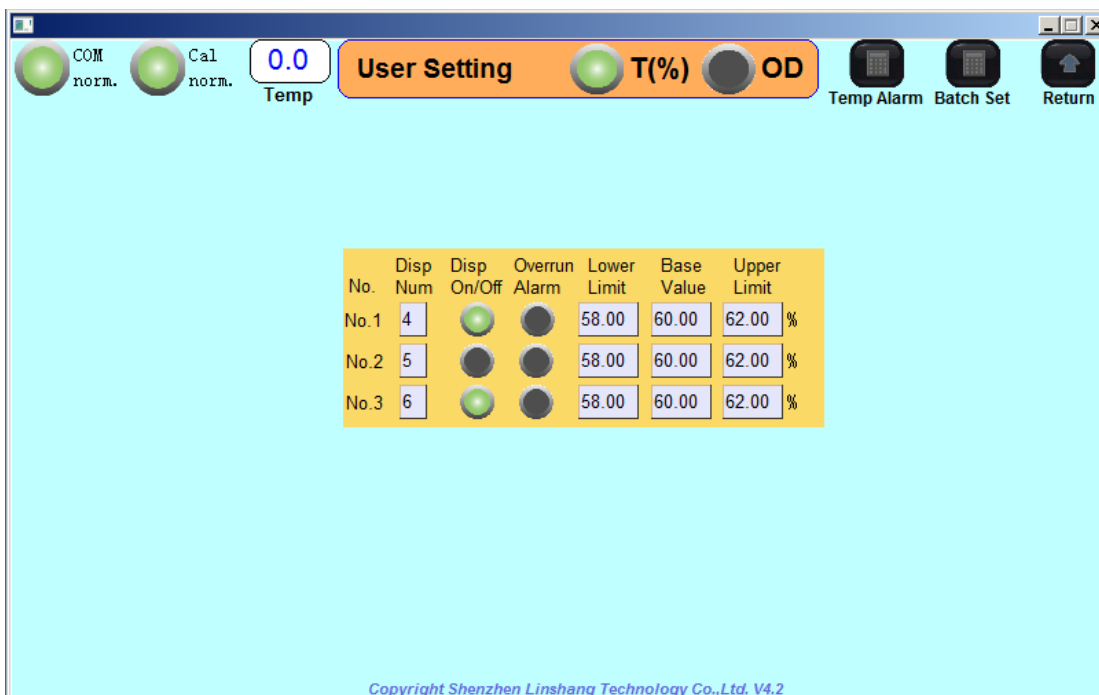

No.	Disp Num	Disp On/Off	Overrun Alarm	Lower Limit	Base Value	Upper Limit
No.1	4	<input checked="" type="checkbox"/>	<input type="checkbox"/>	58.00	60.00	62.00 %
No.2	5	<input type="checkbox"/>	<input type="checkbox"/>	58.00	60.00	62.00 %
No.3	6	<input checked="" type="checkbox"/>	<input type="checkbox"/>	58.00	60.00	62.00 %

Copyright Shenzhen Linshang Technology Co.,Ltd. V4.2

After the setting is completed and saved, enter the "Real-time Monitoring" interface, and only the interface

of point 4 and point 6 will be displayed as shown below:

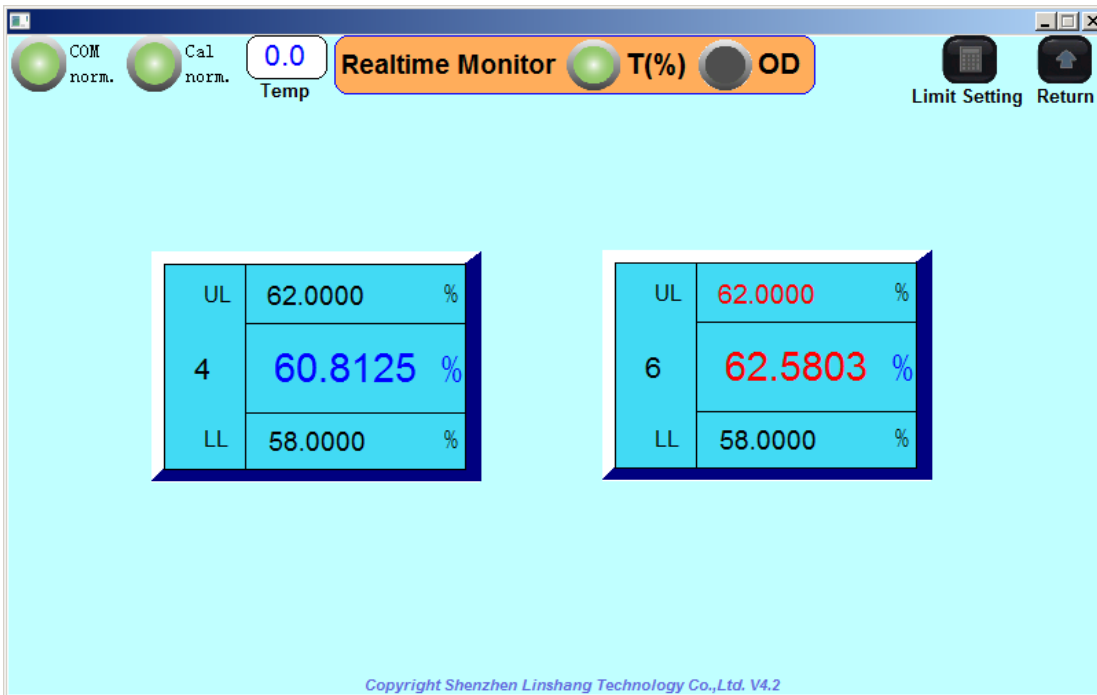

Enter the "Histogram" interface, and only the point 4 and point 6 interface will be shown as below:



Example 2: For user who use optical density display, assuming a test sample with an optical density base value of 0.22, the upper limit is set to 0.23, the lower limit is set to 0.21, and the display points are 7, 8, 9; Point 8 and point 9 display. Over-limit alarms are turned off as shown below:

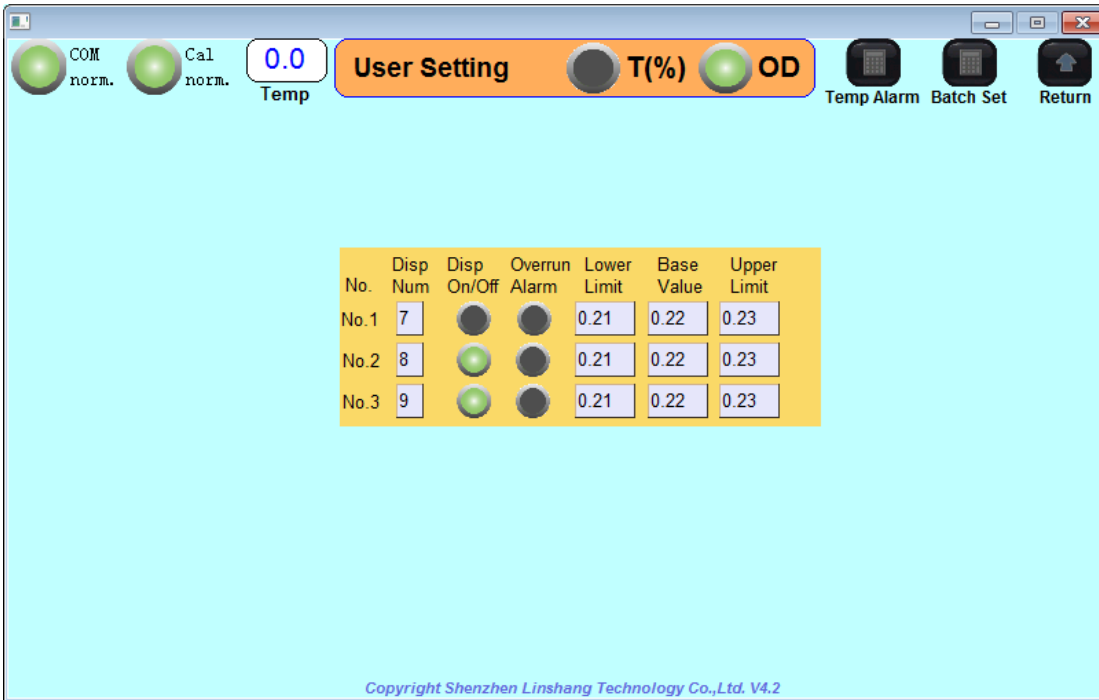

After the setting is completed and saved, enter the "Real-time Monitoring" interface, and only the interface of point 8 and point 9 will be displayed as shown below:

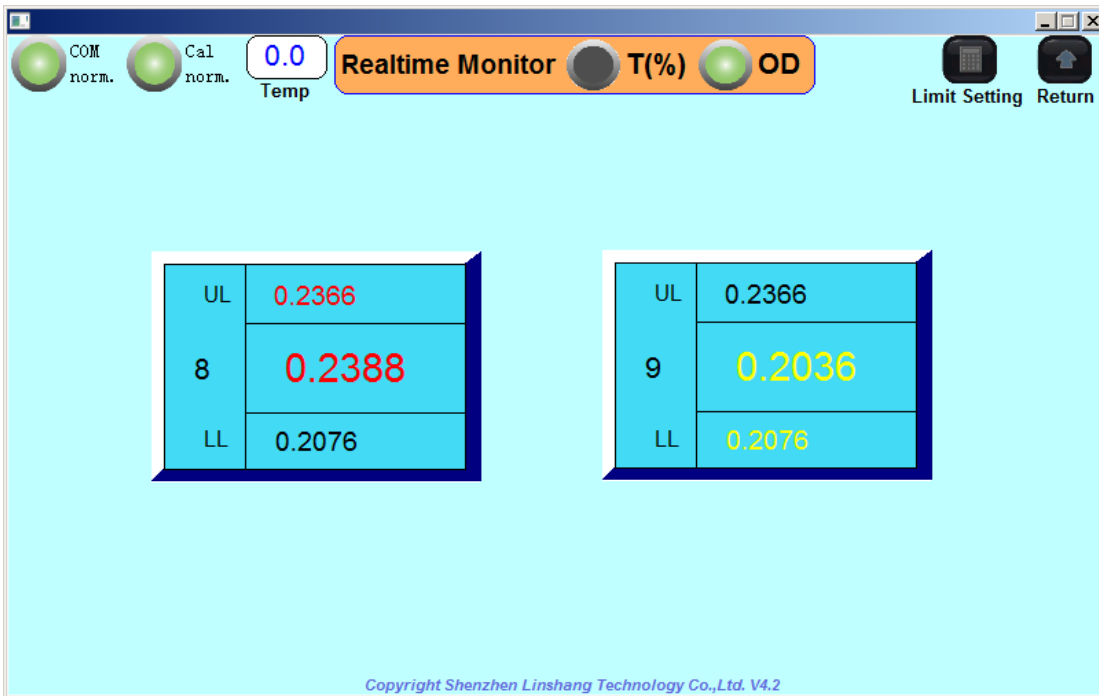

Enter the "Histogram" interface and only the interface of point 8 and point 9 can be displayed as shown below:



The “Temperature Alarm” button in the upper right corner is provided to the user to monitor the internal temperature of the “Control console”. In general, this temperature is the temperature inside the coating machine where the “Control console” is placed. After clicking, the following settings interface appears:

The user can set the upper and lower limits of the temperature and the alarm switch. After the setting is completed, click “Save” button. If the upper and lower limits are set, the alarm switch is turned on. When the temperature exceeds the upper and lower limits, an alarm sound of “click” will be generated, and the temperature in the upper left corner of the interface will be red and flash. As shown below:

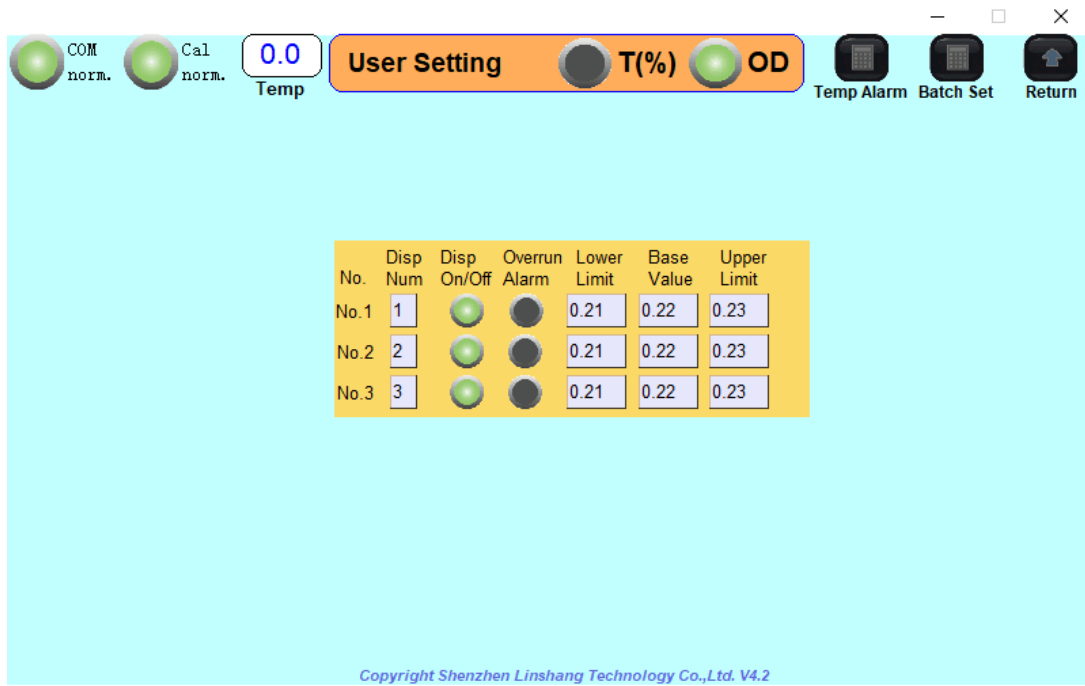

4. Manual Calibration

Click the “Manual Calibration” icon to enter the manual calibration interface as shown below:

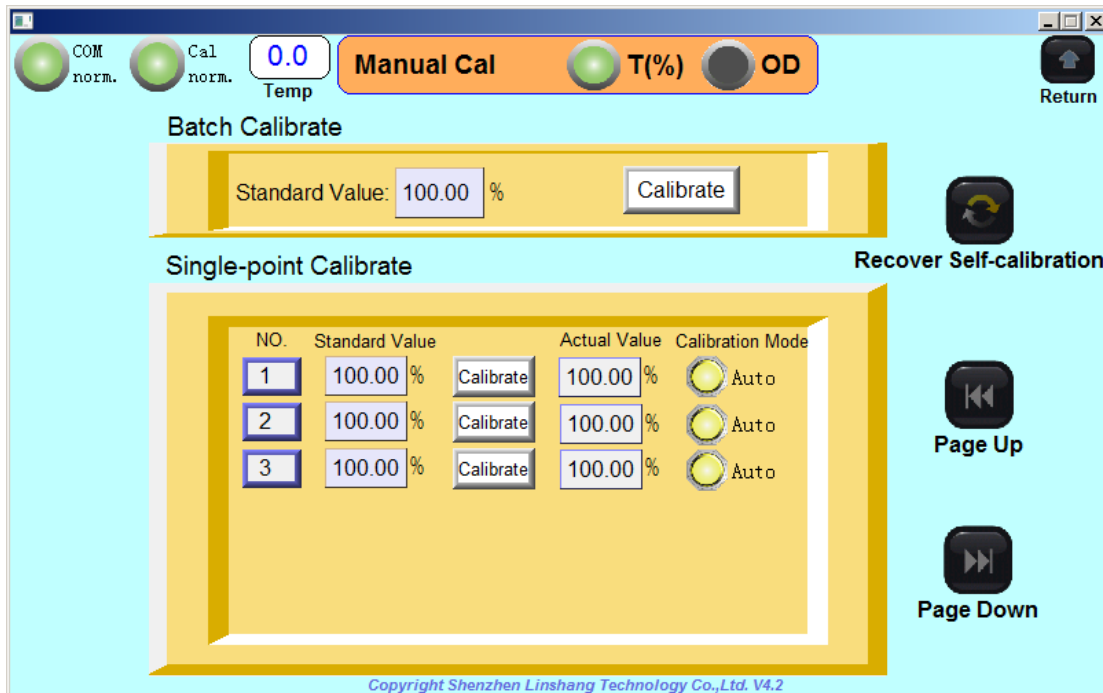

Manual calibration is provided for the user to refer to their own standard sample as the standard measurement calibration; the user can also make zero calibration (with no test object; the calibration transmittance can reach 100%, or optical density can reach 0).

Calibration methods include: batch calibration and single point calibration

Batch calibration means the user can enter the standard value in the input box and click the “Calibrate”

button, all test points are set to standard values, the calibration mode of each point changes from automatic mode to manual mode, but it should be ensured that each test slot has the same standard sample before the batch calibration. If zero calibration is performed, the standard sample is not required, when there is no test sample between the test slots, the transmittance value is calibrated to 100%, or the optical density value is calibrated to 0.

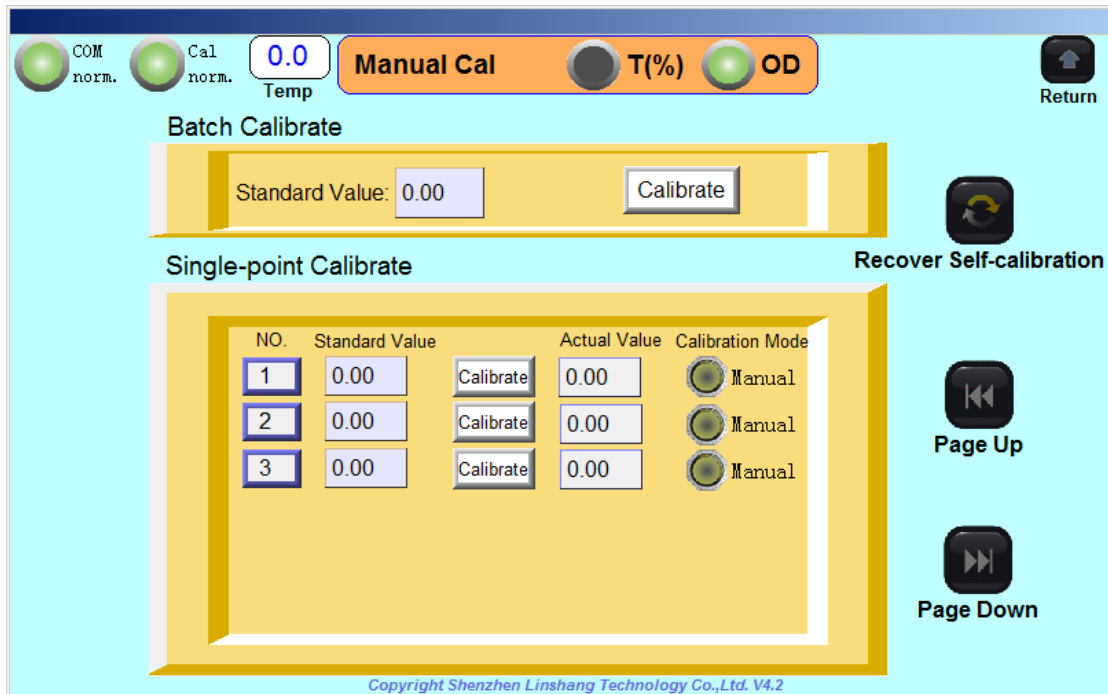
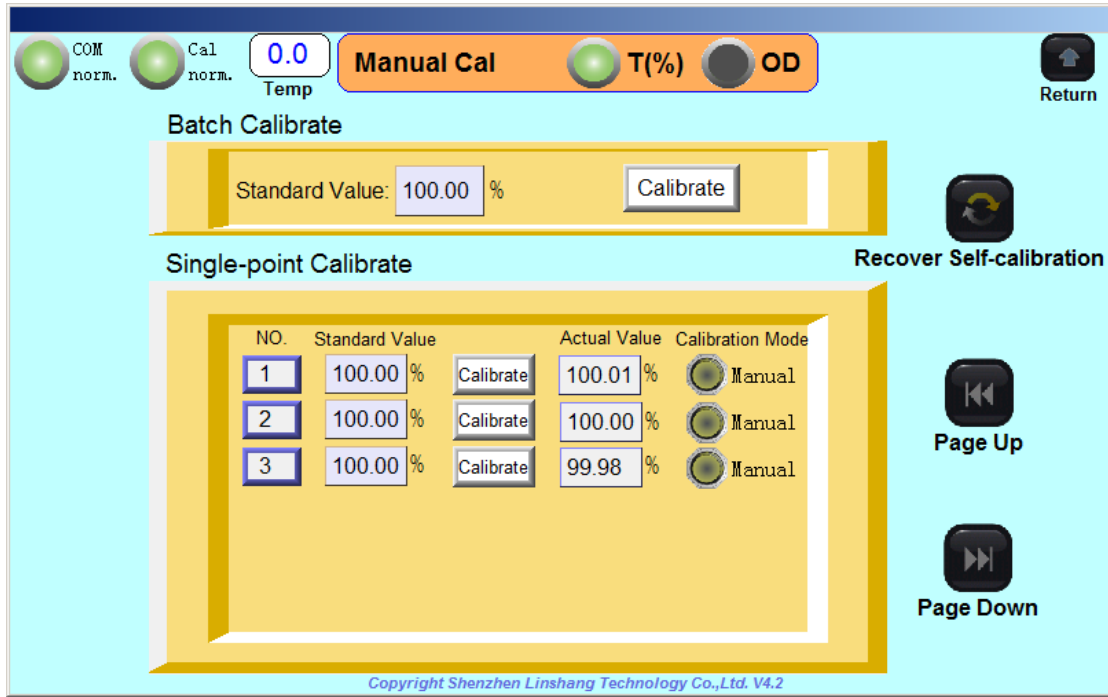

In the manual calibration mode, the transmittance value displayed may be greater than 100% or less than 100% in the absence of the test sample. The optical density value may be greater than 0 or less than 0 in the absence of the test sample. If the deviation of transmittance or optical density is large after long-term use, zero calibration is required before using it. In the auto calibration mode, the transmittance value will

not exceed 100% and the optical density value will not be less than zero.

Single point calibration requires entering the standard value after the corresponding test point number and then clicking the "Calibration" button. However, before each test point is calibrated, it must be ensured that the test slot has a standard sample (zero calibration does not require a sample). When the corresponding points is more than 6. The user can click the "Page Up" and "Page Down" on the right to turn pages.

When a test point is manually calibrated, the calibration mode of the set of probe changes from automatic calibration to manual calibration, and the measured value shows the measured data after calibration.

Example 1: There is a standard sample with a transmittance of 63.10%. It is calibrated to test points 1, 2, and 3 by single-point calibration. First, put the standard sample on the No. 1 test slot, and then enter 63.10 in the standard value. Click "Calibration", the measured value of test point No.1 becomes 63.10%. the calibration mode of test point 1 changes from automatic calibration to manual calibration as shown below:

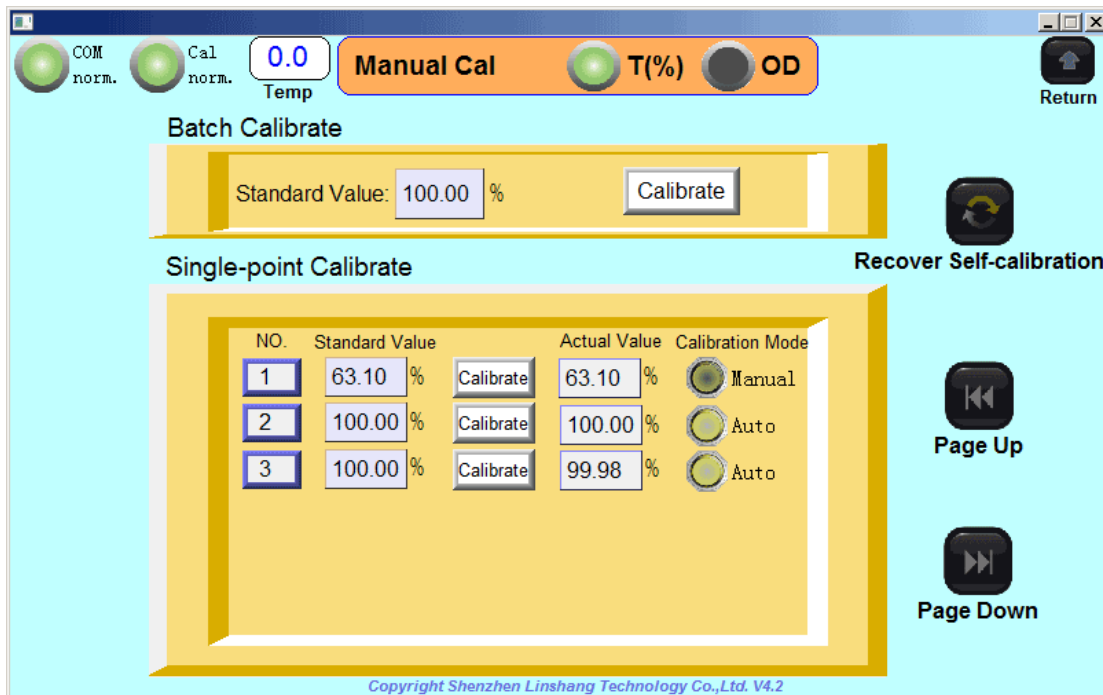

Example 2: When the user uses the optical density display mode, if there is a standard sample with an optical density of 0.22, first place the standard sample on the No. 1 test slot, enter 0.22 in the standard value, and then click "Calibrate". The measured value of test point No. 1 becomes 0.22. the calibration mode of test point 1 changes from automatic calibration to manual calibration as shown below:

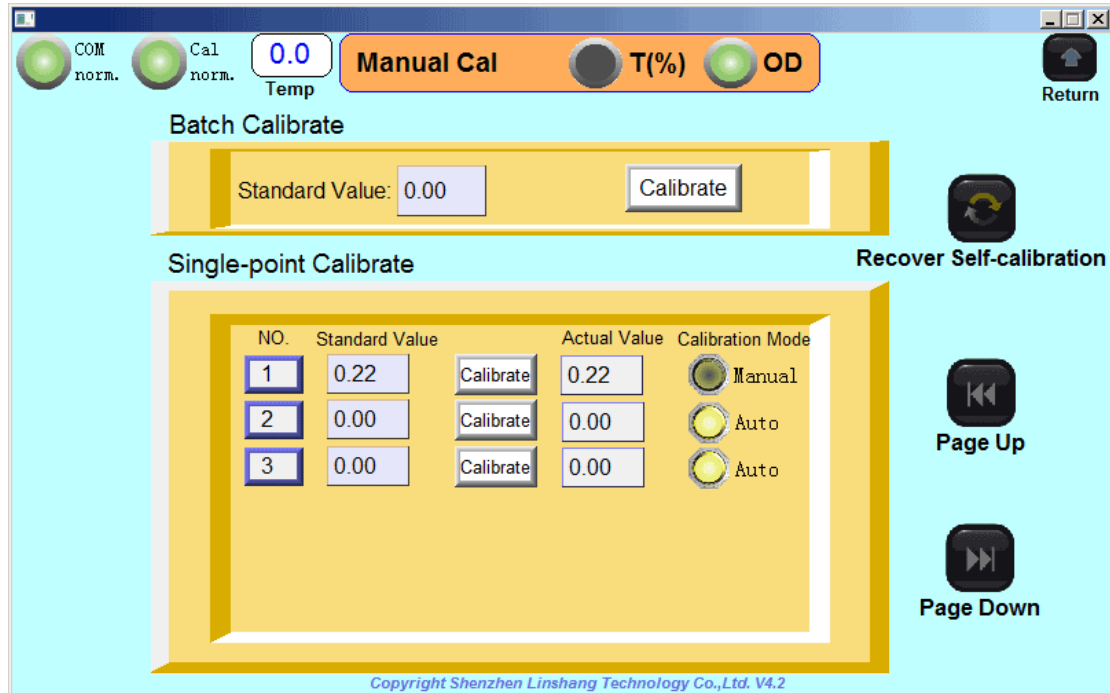

The user can perform a single point calibration for all test points as described above.

If the manual calibration needs to be restored to automatic calibration, click the "Recover Self-Calibration" icon on the right, and the following interface will appear:

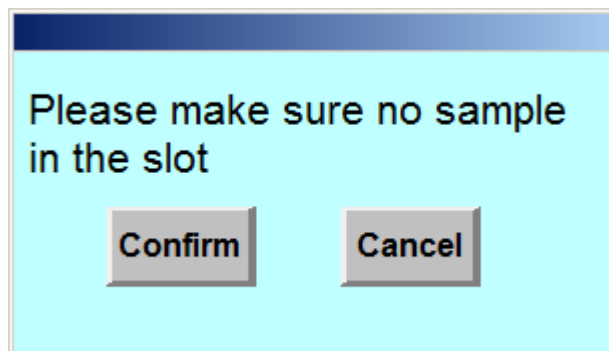

After ensuring that there is no sample in the test slot, click the "Confirm" button to return to automatic calibration.

Note: Manual calibration must be used when the user has a standard sample, otherwise it is not recommended for users. The use of manual calibration will result in no return to full scale without test object or light source attenuation, so it is generally recommended that users use automatic calibration.

5. Communication Configuration

Click on the "Communication Configuration" icon and the password input box will appear as shown below:

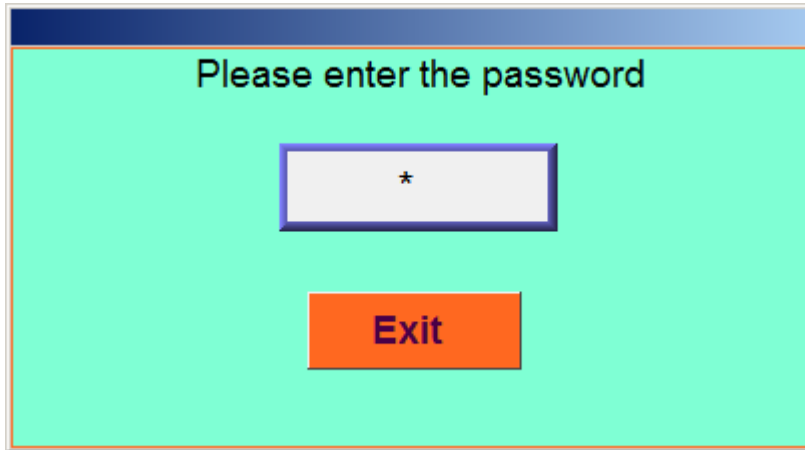

Click the password input box and input 20130326 (User password) and then click “ENT” to enter the interface of communication configuration as below:

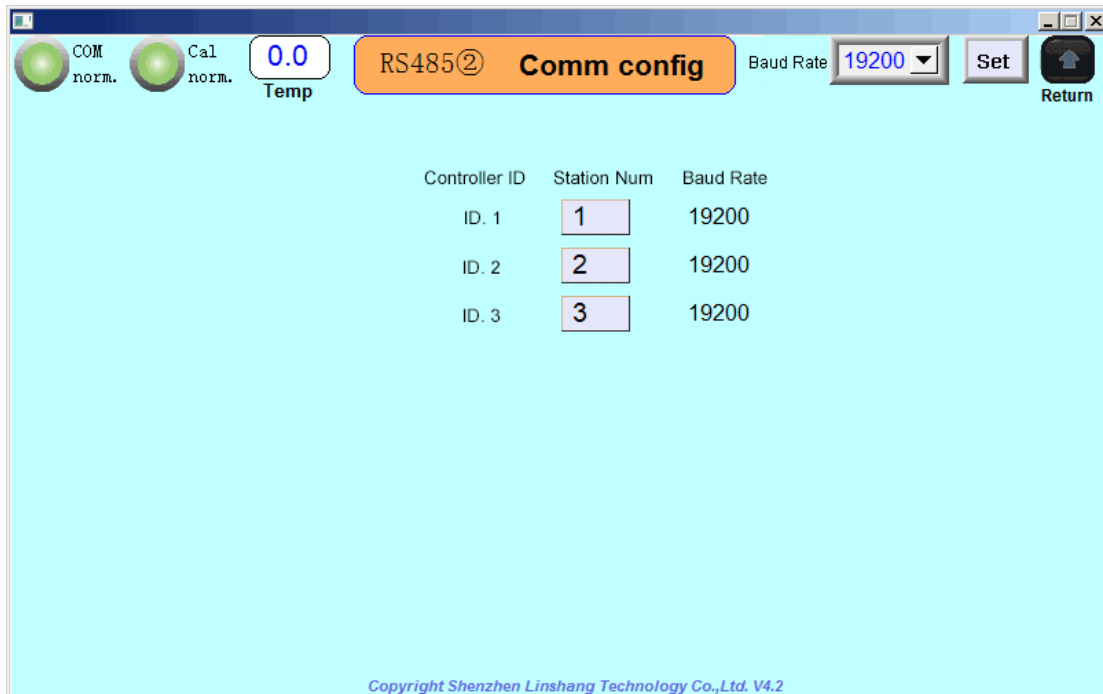

The communication configuration is used to facilitate the communication between the user and the host computer (PC) or the closed-loop control of the coating machine. This communication configuration is set to RS485② (**RS485① communicates with the Human Machine Interface cannot be changed**), and the station number and baud rate can be configured. The default value of the station number is “Probe ID”. The probe id is the fixed natural number starting from 1 inside the device and the corresponding label is placed on the probe.

Station number: the number can be set as any number between 1~246, the same station number cannot appear; the station number is the address code in the MODBUS protocol.

Baud rate: The currently available baud rate is 4800, 9600, 15200 or 38400;

Click the “Set” button after the setting is completed, and the station number and baud rate will be changed.

If the station number 1,2,3 have been used, the communication station number can be set as 5, 7, and 9. The baud rate can also be set as needed. Click the “Set” button after the setting is completed as shown below:

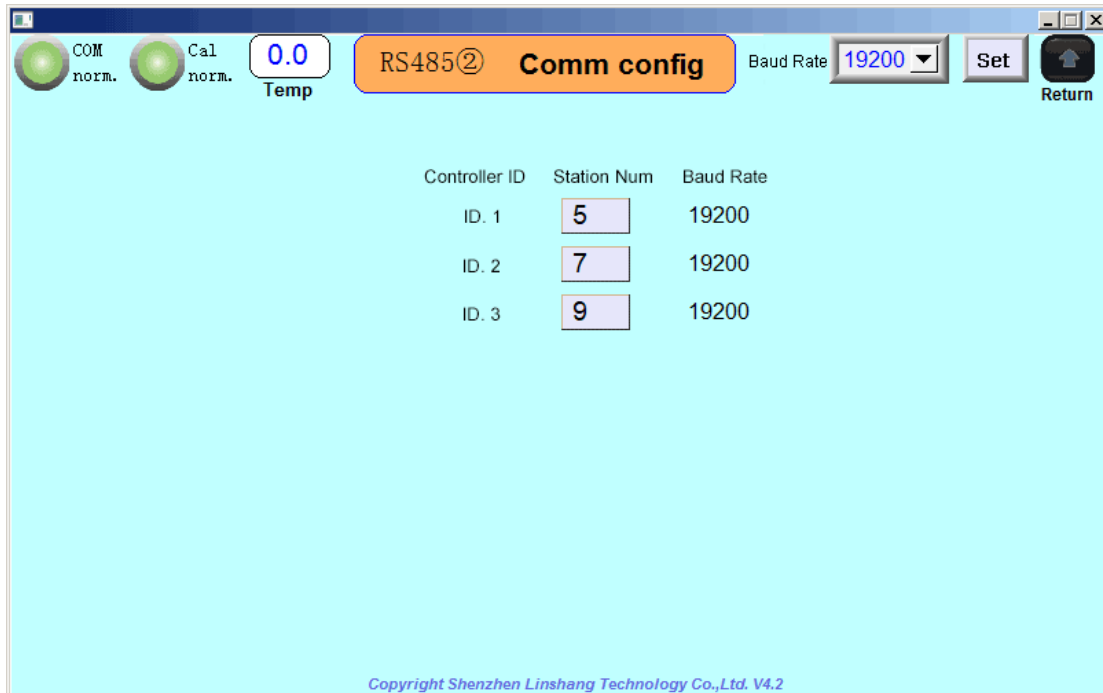

If the setting is completed successfully, the baud rate of each station number will be updated to the set baud rate. The PC and PLC can communicate with the LS153 through the station number and baud rate just used. If the baud rate with station number is not updated to the currently set baud rate, it means that the station number is not set successfully and needs to be set again.

6. System State

Click the “System State” icon to enter the interface of System State as shown below:

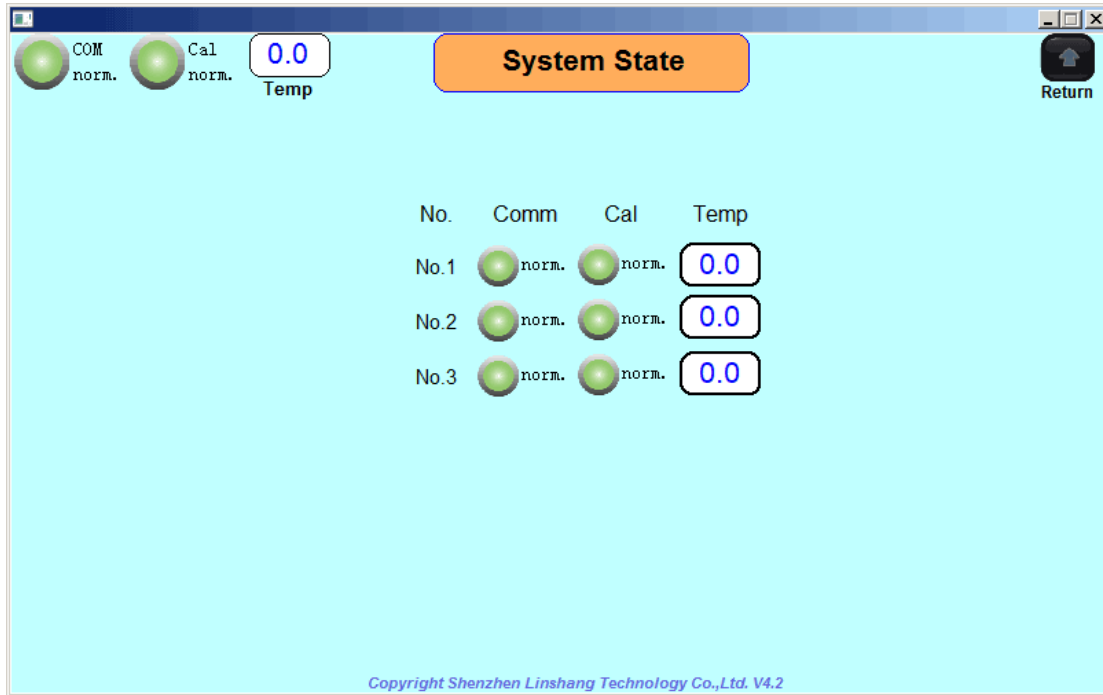

In this interface, the communication and calibration of each test point can be supervised. The environment temperature of each probe can also be checked. When the communication indicator or calibration indicator of the main interface shows abnormality, the user can enter into the interface to check which test point goes wrong.

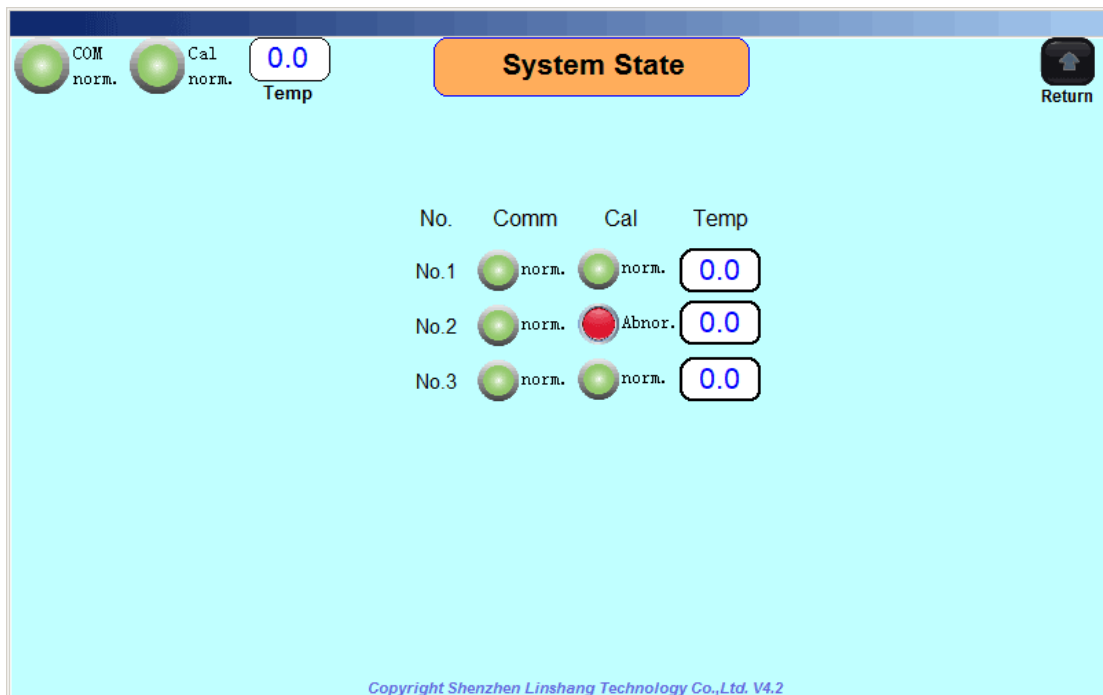

As shown in the above figure, the calibration of the 2nd test point is abnormal. The cause may be the attenuation of the light source, the wrong calibration method or too much dust on the test point. If this happens, please refer to the third section of this manual to solve the problem, or the user can also contact with the supplier.

7. System Configuration

System configuration is Original manufacturer configuration function and is not open to users.

8. Communication Test

The communication test interface can be entered by clicking the icon of “communication test” as shown below:

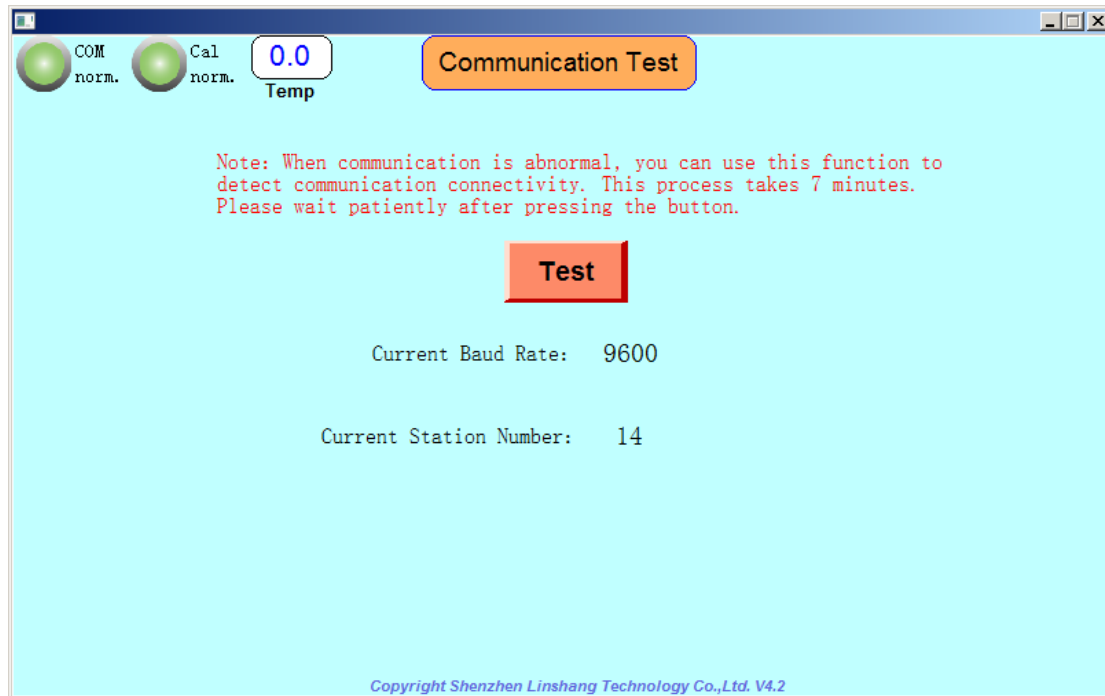

This function is mainly used when the communication is abnormal, and the reason cannot be clarified after eliminating the problem of line connection. The communication polling test can be performed by using the “test” button in the above figure. The general test time is 7 minutes. After the test is completed, the station that can communicate and the baud rate can be displayed. This test can test the communication status of RS485①, and the communication status of RS485②. When RS485② is tested, the RS485② communication interface needs to be interfaced with the Human Machine Interface communication interface.

If there is a “Control console” with 9 test points, the following result will be shown by clicking the test button when the communication of RS485① is normal:

Station Num	Baud Rate	Station Num	Baud Rate
1	19200		
2	19200		
3	19200		

It can be seen from the test results that the station numbers that can communicate normally are 1, 2, and 3, and the baud rate is 19200. If one receiving probe is broken, the corresponding station number and baud rate will not be detected.

Many users will develop their own Human-machine Interface software according to the communication protocol. After modifying the station number and baud rate according to their own situation, there will be a problem that the debugging communication cannot be connected. At this time, the function can be used to detect the set station number and baud rate, making it easy to reset and debug.

II. Description of Common Abnormity

1. Communication Abnormal Description

After the power is turned on, when the communication indicator in the upper left corner of the display unit shows that there is something abnormal, and the calibration indicator is abnormal, and when there is no temperature display, the user can enter the "System State" interface to check.

If all the controller are abnormal, it indicates that the Human Machine Interface is not communicating. There are three general reasons for the communication abnormality:

- 1) The power supply of the "measure and control host" is abnormal. Check whether the 7.5V power cable of the "measure and control host" and the "Human Machine Interface control box" is correctly connected. The multimeter can be used to measure whether the Power Supply voltage is 7.5V.
- 2) The communication cable is not wired correctly. Check if the RS485①communication line of the "measure and control host" and "Human Machine Interface control box" is connected correctly.

- 3) The receiving probe is damaged and needs to be returned to the factory for repair.

If only some of the test points communicate abnormally, it is because the corresponding receiving probe is damaged, or it is because there is a problem with the connection line, and it should be returned to the supplier for repair.

2. Calibration Abnormal Description

When the calibration indicator in the upper left corner of the display unit is abnormal, it can be checked which point or which points is abnormal in the “System State” interface. Generally speaking there are four reasons for the abnormality of calibration status:

- 1) The light path is blocked by dust, and the lens glass of the corresponding point can be wiped with a dust-free cloth.
- 2) In the automatic calibration state, there is a sample in the test slot when starting up.
- 3) The difference between the standard values of manual calibration and calibration plate is too big in the process of manual calibration.
- 4) The light source is permanently damaged. Please return it to the factory for repair.

3. Probe Abnormal Description

When the measure transmittance of the Human Machine Interface with test points displays “11.1100” all the time, or when the measured optical density always displays “0.9543”, and the above-mentioned phenomenon keeps happening no matter if there is test object or if the device is restarted, it means the corresponding test points is broken, The set of probes (receiving probe and light source probe) should be sent back to the factory for inspection and maintenance.

When the measure transmittance of the Human-machine Interface with test points displays “88.8800” all the time, or when the measured optical density always displays “0.0512”, and the above-mentioned phenomenon keeps happening no matter if there is test object or if the device is restarted, it means the corresponding test points is broken. The set of probes (receiving probe and light source probe) should be sent back to the factory for inspection and maintenance.

When the temperature on the main interface of Human-machine Interface keeps showing “88.8”, or when the probe temperature under “System State” interface keep displaying “88.8”, it means the temperature sensors of the probe is broken, and the corresponding receiving probe can be sent back to the factory for repair.

Manufacturer: Shenzhen Linshang Technology Co., Ltd.

Website: www.linshangtech.com

Service hotline: 086-755-86263411

Email: sales21@linshangtech.com