

Coating Thickness Gauge

Model: LS226

User Manual V1.03

Please read this manual carefully before using and reserve it for reference.

I Product introduction

The coating thickness gauge can be used not only to measure non-magnetic coatings such as paint, varnish, enamel, chrome and galvanizing on ferromagnetism metal substrates such as steel or iron, but also measure Non-conductive coatings such as paint, anodized layers or ceramic on non-magnetic metal substrates such as copper, aluminum, die cast zinc, brass etc. The gauge automatically identifies the substrate and switch measurement mode. It is widely used in manufacturing, metal processing, chemical industry, commodity inspection and other fields.

Standards for the product:

- *GB/T 4956-2025 Non-magnetic Coatings on Magnetic Substrates-Measurement of Coating Thickness-Magnetic Method*
- *GB/T 4957-2025 Non-conductive Coatings on Non-magnetic Basis Metals-Measurement of Coating Thickness-Eddy Current*
- *DIN EN ISO 2808 Paints and Varnishes-Determination of Film Thickness*
- *JJG-818-2018 Verification Regulation of Magnetic and Eddy Current Measuring Instrument for Coating Thickness*

II Technical parameters

Probe tip	Cemented carbide
Measuring principle	Fe: Magnetic Induction / NFe: Eddy current
Probe type	Integrated probe
Measuring range	0.0-2000μm
Resolution	0.1μm:(0μm - 99.9μm) 1μm:(100μm - 2000μm)
Accuracy	0-1000μm:≤±(2%H+1μm), H is the standard value 1000-2000μm:≤±3%H, H is the standard value
Unit	μm / mil
Measuring interval	0.3s
Minimum measuring area	∅ = 15mm
Minimum substrate thickness	Fe:0.2mm / NFe:0.05mm
Display	128x48 dot matrix LCD
Power supply	2pcs of 1.5V AA alkaline battery



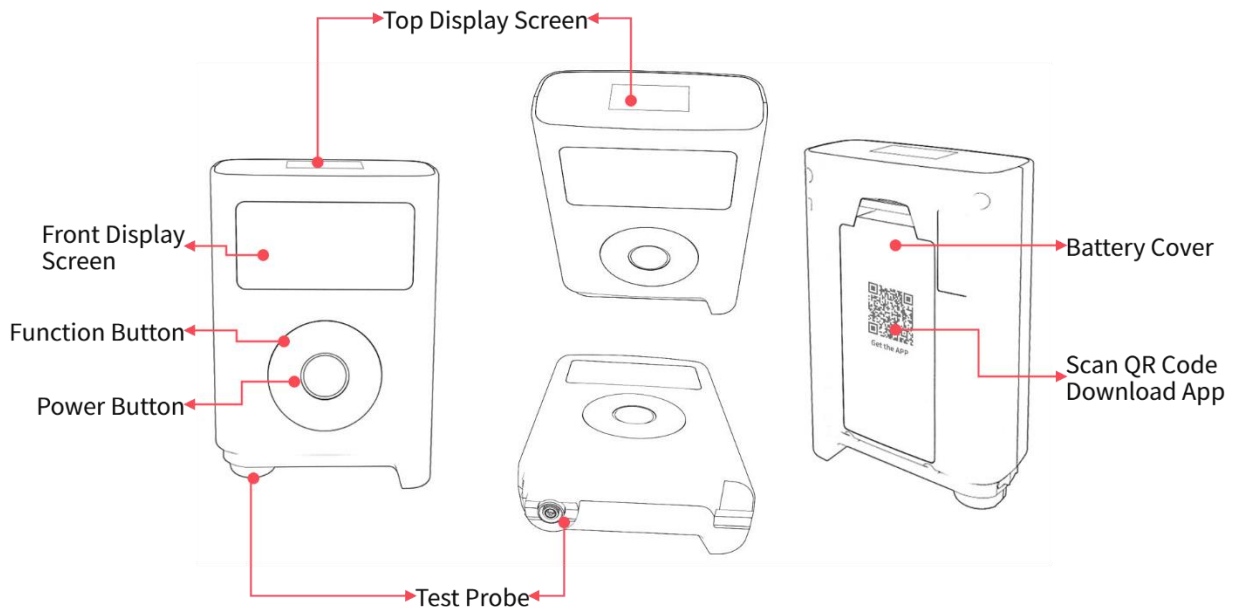

Operating temperature range	0℃~50℃, 0~85%RH(no condensation)
Storage temperature range	-10℃~60℃, 0~85%RH(no condensation)
Host size	90*65*28 mm
Weight(with battery)	123g
Supply voltage	DC3V
Operating current	35mA
Operating power consumption	105mW

III Operation

1. Instrument structure



2. Settings

Short press the  button to enter the main settings interface, where you can adjust settings such as language, zero adjustment, calibration, measurement mode, substrate type, unit selection, continuous measurement, and factory reset. Short press the   button to select, short press the  button to confirm, and short press the  button to return.

2.1 Zero adjustment

For accurate measurement, a zero-adjustment is required when using the gauge for the first time, after

inserting new batteries, working with different materials, ambient temperature changes or long-term no-use. We strictly recommend carrying out the reference check on the uncoated original substrate, due to the difference of magnetic and conductive properties of the material, some measurement deviation will be caused. If this is not possible, please use the zero reference plates supplied with in the case, there are Fe plate and NFe plate, please choose correctly according to the measuring materials.

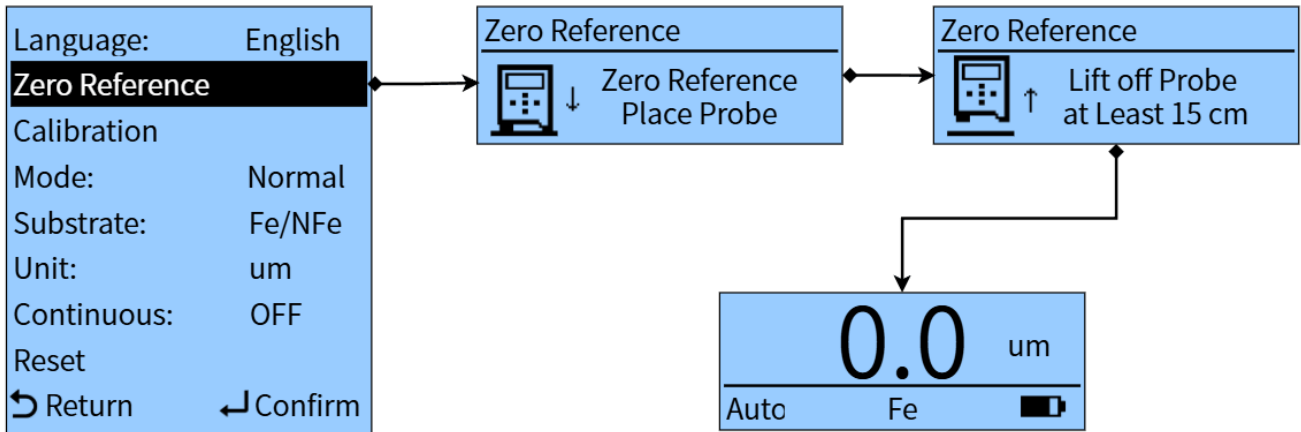

Zero adjustment steps

Note: After the zero adjustment completed, when repeating measurement on the same spot, the reading may not always be $0\mu\text{m}$, since surface roughness, dirt, scratches etc. might cause variances. The operation of the gauge should be correct and proficient; otherwise, it will lead to instability of the measured values.

2.2 Calibration

The instrument can be calibrated from 1 point to 5 points.

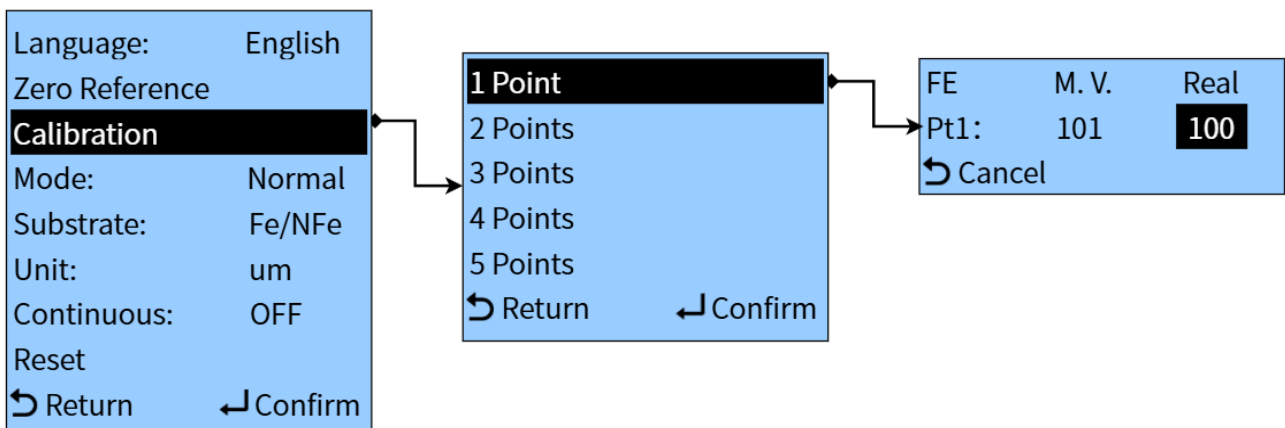

Calibration steps

2.3 Mode settings

The instrument can be set in two modes: "Normal Mode" and "QC Mode".

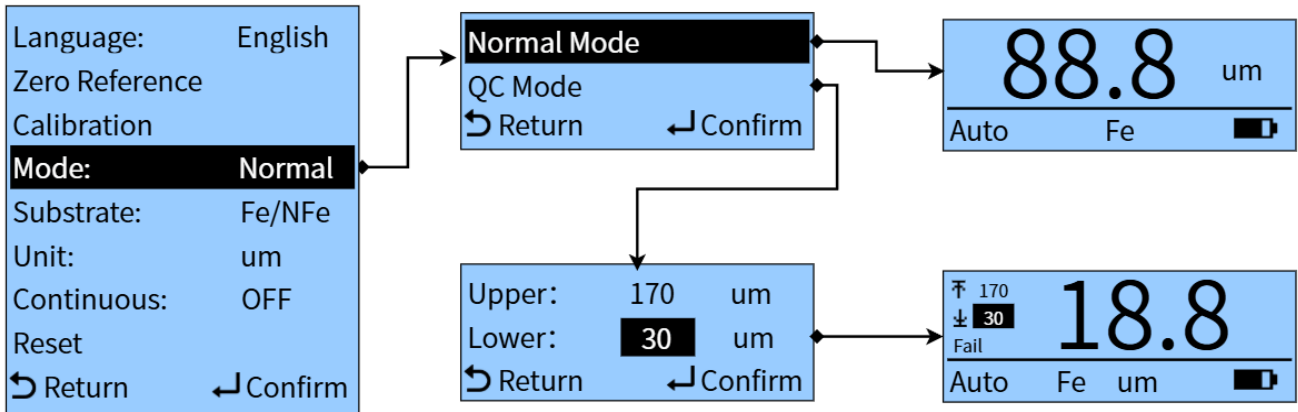

Mode setting steps

2.4 Selection of measurement substrates

It has three measurement modes: iron-substrate measurement mode (Fe), non-ferrous substrate measurement mode (NFe) and automatic identification mode (Fe/NFe).

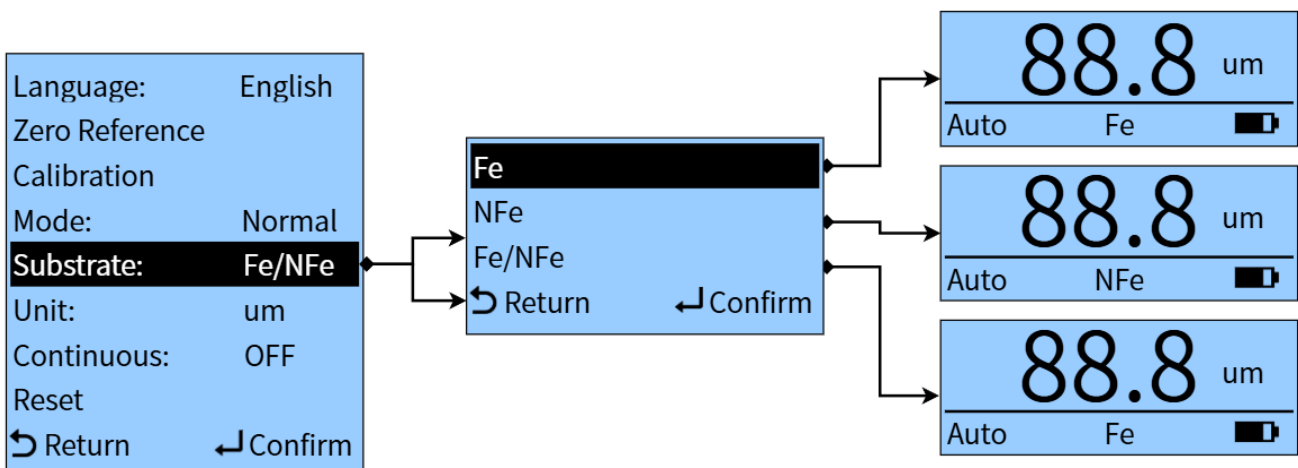

Substrate setup steps

2.5 Continuous measurement

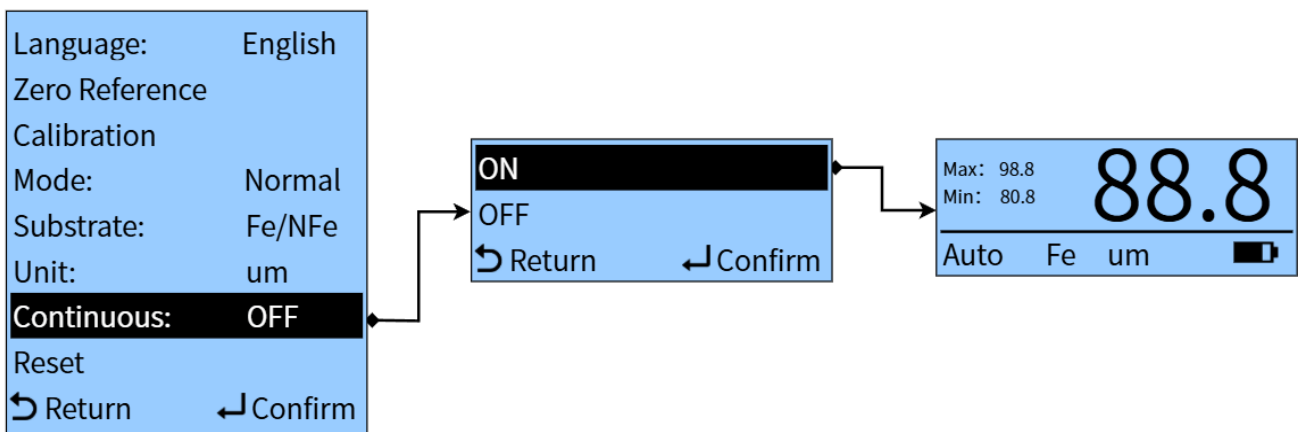

Continuous measurement setup steps

2.6 Reset

The factory default settings are as follows:

Item	Language	Unit	Mode	Continuous	Substrate	Upper	Lower
Reset	No Reset	μm	Normal	OFF	Fe/NFe	170μm	30μm

Note: Saved data and calibrations are also cleared.

3. Measurement

● Single Measurement



Place the instrument on the surface of the object to be measured. Keep the probe steady and do not tilt or shake it. The result will be shown on the screen, and there will be a buzzer.

● Continuous Measurement

Turn on the continuous measurement, measure a data in about 0.1s, and drag the instrument to measure different positions of the object.

Note: After turning on continuous measurement, the measurement data will not be stored and the history record interface cannot be entered.

4. Check measurement records

Short press the   button to view the historical data. Short press the  button to enter the confirmation interface for deleting the current record, and follow the prompts to delete. The instrument stores 9 sets of data in total. When more than 9 sets of data are stored, the oldest record value will be automatically deleted.

IV Bluetooth communication

The instrument has a built-in Bluetooth communication module, which can be connected to the instrument via a mobile phone APP.

- 1) Scan the QR code on the back of the instrument, and follow the prompts to download and install the corresponding "UT and HL" APP.
- 2) APP Connect device: Open the APP, search for the device and establish a connection according to the prompts.

Note: The APP does not support iOS. Please allow all permissions when running the APP.

V Precaution

1. The instrument has the best stability in single measurement mode. It is recommended to select single measurement mode for precision measurement.

2. During the measurement, the probe should be kept at the center of the point to be measured, and the periphery of the probe should not be suspended outside the surface to be measured.
3. Keep away from strong magnets (magnets, stereos, etc.) and strong electromagnetic fields (transformers, induction cookers, etc.).
4. Before using the instrument, it is recommended to perform a multi-point calibration operation.
5. Please ensure that the surface of the object under test is clean, dust and dirt on the surface to be tested will affect the measurement accuracy.
6. When the screen display low battery, new battery should be used.

VI Packing list

No.	Description	Quantity	Unit
1	Coating Thickness Gauge	1	Set
2	Fe zero-adjustment plate	1	pcs
3	NFe zero-adjustment plate	1	pcs
4	Standard film	5	pcs
5	User manual	1	pcs

VII Service

1. The gauge has one-year warranty. If the gauge works abnormally, please send the whole gauge to our company for maintenance.
2. Provide users with spare parts and lifelong maintenance services.
3. Provide the users with the gauge calibration service.
4. Free technical support for long term.

Manufacturer: Shenzhen Linshang Technology Co., Ltd.

Website: www.linshangtech.com

Service hotline: 086-755-86263411

Email: sales21@linshangtech.com